



OWNER'S MANUAL

MAJESTY

400

YP400

YP400A

5RU-28199-E3

DECLARATION of CONFORMITY

We

Company: MORIC CO., LTD.

Address: 1450-6 Mori Mori-Machi Shuchi-gun Shizuoka 437-0292 Japan

Hereby declare that the product:

Kind of equipment: IMMOBILIZER

Type-designation: 5SL-00

is in compliance with following norm(s) or documents:

R&TTE Directive(1999/5/EC)

EN300 330-2 v1.1.1(2001-6), EN60950-1(2001)

Two or Three-Wheel Motor Vehicles Directive(97/24/EC: Chapter 8, EMC)

Place of issue: Shizuoka, Japan

Date of issue: 1 Aug. 2002

Revolution record

No.	Contents	Date
1	To change contact person and integrate type-designation.	9 Jun. 2005
2	Version up the norm of EN60950 to EN60950-1	27 Feb. 2006

27/Feb/2006

General manager of quality assurance div.

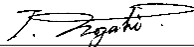

representative name and signature

MORIC CO., LTD.

1450-6 Mori-machi Shuchi-gun Shizuoka 437-0292 JAPAN Telephone +81-538-85-0757 Facsimile +81-538-85-0456

URI: <http://www.moric-jp.com>

Welcome to the Yamaha world of motorcycling!

As the owner of the YP400/YP400A, you are benefiting from Yamaha's vast experience and newest technology regarding the design and manufacture of high-quality products, which have earned Yamaha a reputation for dependability.

Please take the time to read this manual thoroughly, so as to enjoy all advantages of your YP400/YP400A. The owner's manual does not only instruct you in how to operate, inspect and maintain your scooter, but also in how to safeguard yourself and others from trouble and injury.



In addition, the many tips given in this manual will help keep your scooter in the best possible condition. If you have any further questions, do not hesitate to contact your Yamaha dealer.

The Yamaha team wishes you many safe and pleasant rides. So, remember to put safety first!

IMPORTANT MANUAL INFORMATION

EAU34111

Particularly important information is distinguished in this manual by the following notations:

	The Safety Alert Symbol means ATTENTION! BECOME ALERT! YOUR SAFETY IS INVOLVED!
 WARNING	Failure to follow WARNING instructions could result in severe injury or death to the scooter operator, a bystander, or a person inspecting or repairing the scooter.
CAUTION:	A CAUTION indicates special precautions that must be taken to avoid damage to the scooter.
NOTE:	A NOTE provides key information to make procedures easier or clearer.

NOTE:

- This manual should be considered a permanent part of this scooter and should remain with it even if the scooter is subsequently sold.
- Yamaha continually seeks advancements in product design and quality. Therefore, while this manual contains the most current product information available at the time of printing, there may be minor discrepancies between your scooter and this manual. If you have any questions concerning this manual, please consult your Yamaha dealer.

EWA12410

WARNING

PLEASE READ THIS MANUAL CAREFULLY AND COMPLETELY BEFORE OPERATING THIS SCOOTER.

*Product and specifications are subject to change without notice.

IMPORTANT MANUAL INFORMATION

EAU10200

**YP400/YP400A
OWNER'S MANUAL
©2006 by Yamaha Motor Co., Ltd.
1st edition, August 2006
All rights reserved.
Any reprinting or unauthorized use
without the written permission of
Yamaha Motor Co., Ltd.
is expressly prohibited.
Printed in Japan.**

TABLE OF CONTENTS

SAFETY INFORMATION	1-1	Ignition circuit cut-off system	3-19	Valve clearance	6-21
Further safe-riding points	1-4			Tires	6-21
DESCRIPTION	2-1	PRE-OPERATION CHECKS	4-1	Cast wheels	6-23
Left view	2-1	Pre-operation check list	4-2	Front and rear brake lever free play	6-24
Right view	2-2	OPERATION AND IMPORTANT RIDING POINTS	5-1	Adjusting the rear brake lock lever cable	6-24
Controls and instruments.....	2-3	Starting the engine	5-1	Checking the front and rear brake pads	6-25
INSTRUMENT AND CONTROL FUNCTIONS	3-1	Starting off	5-2	Checking the brake fluid level	6-26
Immobilizer system	3-1	Acceleration and deceleration	5-2	Changing the brake fluid	6-27
Main switch/steering lock	3-2	Braking	5-2	Checking and lubricating the cables	6-27
Indicator and warning lights	3-3	Tips for reducing fuel consumption	5-3	Checking and lubricating the throttle grip and cable	6-27
Speedometer	3-4	Engine break-in	5-4	Lubricating the front and rear brake levers	6-28
Tachometer	3-5	Parking	5-4	Checking and lubricating the centerstand and sidestand	6-28
Multi-function display	3-5	PERIODIC MAINTENANCE AND MINOR REPAIR	6-1	Checking the front fork	6-29
Anti-theft alarm (optional)	3-9	Owner's tool kit	6-1	Checking the steering	6-29
Handlebar switches	3-9	Periodic maintenance and lubrication chart	6-3	Checking the wheel bearings	6-30
Front brake lever	3-10	Removing and installing cowlings and panels	6-6	Battery	6-30
Rear brake lever	3-11	Checking the spark plug	6-10	Replacing the fuses	6-32
Rear brake lock lever	3-11	Engine oil and oil filter element	6-12	Replacing a headlight bulb	6-34
ABS (for ABS models)	3-12	Final transmission oil	6-15	Tail/brake light	6-34
Fuel tank cap	3-12	Coolant	6-16	Replacing a front turn signal light bulb	6-35
Fuel	3-13	Air filter elements and check hoses and V-belt case air filter element	6-18	Replacing a rear turn signal light bulb	6-36
Catalytic converter	3-14	Checking the throttle cable free play	6-20		
Seats	3-14				
Adjusting the rider seat	3-16				
Storage compartments	3-16				
Adjusting the shock absorber assemblies	3-18				
Sidestand	3-19				

TABLE OF CONTENTS

Replacing the license plate light bulb	6-36
Replacing an auxiliary light bulb	6-37
Troubleshooting	6-38
Troubleshooting charts	6-39

SCOOTER CARE AND STORAGE	7-1
Matte color caution	7-1
Care	7-1
Storage	7-3

SPECIFICATIONS	8-1
-----------------------------	-----

CONSUMER INFORMATION	9-1
Identification numbers	9-1

SAFETY INFORMATION

EAU10261

SCOOTERS ARE SINGLE TRACK VEHICLES. THEIR SAFE USE AND OPERATION ARE DEPENDENT UPON THE USE OF PROPER RIDING TECHNIQUES AS WELL AS THE EXPERTISE OF THE OPERATOR. EVERY OPERATOR SHOULD KNOW THE FOLLOWING REQUIREMENTS BEFORE RIDING THIS SCOOTER.

HE OR SHE SHOULD:

- OBTAIN THOROUGH INSTRUCTIONS FROM A COMPETENT SOURCE ON ALL ASPECTS OF SCOOTER OPERATION.
- OBSERVE THE WARNINGS AND MAINTENANCE REQUIREMENTS IN THE OWNER'S MANUAL.
- OBTAIN QUALIFIED TRAINING IN SAFE AND PROPER RIDING TECHNIQUES.
- OBTAIN PROFESSIONAL TECHNICAL SERVICE AS INDICATED BY THE OWNER'S MANUAL AND/OR WHEN MADE NECESSARY BY MECHANICAL CONDI-

TIONS.

Safe riding

- Always make pre-operation checks. Careful checks may help prevent an accident.
- This scooter is designed to carry the operator and passenger.
- The failure of motorists to detect and recognize scooters in traffic is the predominating cause of automobile/scooter accidents. Many accidents have been caused by an automobile driver who did not see the scooter. Making yourself conspicuous appears to be very effective in reducing the chance of this type of accident.

Therefore:

- Wear a brightly colored jacket.
- Use extra caution when approaching and passing through intersections, since intersections are the most likely places for scooter accidents to occur.
- Ride where other motorists can see you. Avoid riding in another motorist's blind spot.
- Many accidents involve inexperienced operators.

In fact, many operators who have been involved in accidents do not even have a current driver's license.

- Make sure that you are qualified and that you only lend your scooter to other qualified operators.
- Know your skills and limits. Staying within your limits may help you to avoid an accident.
- We recommend that you practice riding your scooter where there is no traffic until you have become thoroughly familiar with the scooter and all of its controls.
- Many accidents have been caused by error of the scooter operator. A typical error made by the operator is veering wide on a turn due to EXCESSIVE SPEED or undercornering (insufficient lean angle for the speed).
 - Always obey the speed limit and never travel faster than warranted by road and traffic conditions.
 - Always signal before turning or

changing lanes. Make sure that other motorists can see you.

- The posture of the operator and passenger is important for proper control.
- The operator should keep both hands on the handlebar and both feet on the footboard during operation to maintain control of the scooter.
- The passenger should always hold onto the operator, the seat strap or grab bar, if equipped, with both hands and keep both feet on the passenger footrests.
- Never carry a passenger unless he or she can firmly place both feet on the passenger footrests.
- Never ride under the influence of alcohol or other drugs.
- This scooter is designed for on-road use only. It is not suitable for off-road use.

Protective apparel

The majority of fatalities from scooter accidents are the result of head injuries. The use of a safety helmet is the

single most critical factor in the prevention or reduction of head injuries.

- Always wear an approved helmet.
- Wear a face shield or goggles. Wind in your unprotected eyes could contribute to an impairment of vision which could delay seeing a hazard.
- The use of a jacket, substantial shoes, trousers, gloves, etc., is effective in preventing or reducing abrasions or lacerations.
- Never wear loose-fitting clothes, otherwise they could catch on the control levers or wheels and cause injury or an accident.
- Never touch the engine or exhaust system during or after operation. They become very hot and can cause burns. Always wear protective clothing that covers your legs, ankles, and feet.
- Passengers should also observe the above precautions.

Modifications

Modifications made to this scooter not approved by Yamaha, or the removal of

original equipment, may render the scooter unsafe for use and may cause severe personal injury. Modifications may also make your scooter illegal to use.

Loading and accessories

Adding accessories or cargo to your scooter can adversely affect stability and handling if the weight distribution of the scooter is changed. To avoid the possibility of an accident, use extreme caution when adding cargo or accessories to your scooter. Use extra care when riding a scooter that has added cargo or accessories. Here are some general guidelines to follow if loading cargo or adding accessories to your scooter:

Loading

The total weight of the operator, passenger, accessories and cargo must not exceed the maximum load limit.

Maximum load:

YP400 189 kg (417 lb)

YP400A 185 kg (408 lb)

SAFETY INFORMATION

When loading within this weight limit, keep the following in mind:

- Cargo and accessory weight should be kept as low and close to the scooter as possible. Make sure to distribute the weight as evenly as possible on both sides of the scooter to minimize imbalance or instability.
- Shifting weights can create a sudden imbalance. Make sure that accessories and cargo are securely attached to the scooter before riding. Check accessory mounts and cargo restraints frequently.
- Never attach any large or heavy items to the handlebar, front fork, or front fender. Such items can create unstable handling or a slow steering response.

Accessories

Genuine Yamaha accessories have been specifically designed for use on this scooter. Since Yamaha cannot test all other accessories that may be available, you must personally be responsible for the proper selection, installation

and use of non-Yamaha accessories. Use extreme caution when selecting and installing any accessories.

Keep the following guidelines in mind, as well as those provided under “Loading” when mounting accessories.

- Never install accessories or carry cargo that would impair the performance of your scooter. Carefully inspect the accessory before using it to make sure that it does not in any way reduce ground clearance or cornering clearance, limit suspension travel, steering travel or control operation, or obscure lights or reflectors.
- Accessories fitted to the handlebar or the front fork area can create instability due to improper weight distribution or aerodynamic changes. If accessories are added to the handlebar or front fork area, they must be as lightweight as possible and should be kept to a minimum.
- Bulky or large accessories may seriously affect the stability of the scooter due to aerodynamic

effects. Wind may attempt to lift the scooter, or the scooter may become unstable in cross winds. These accessories may also cause instability when passing or being passed by large vehicles.

- Certain accessories can displace the operator from his or her normal riding position. This improper position limits the freedom of movement of the operator and may limit control ability, therefore, such accessories are not recommended.
- Use caution when adding electrical accessories. If electrical accessories exceed the capacity of the scooter’s electrical system an electric failure could result, which could cause a dangerous loss of lights or engine power.

Gasoline and exhaust gas

- **GASOLINE IS HIGHLY FLAMMABLE:**
 - Always turn the engine off when refueling.

Further safe-riding points

- Take care not to spill any gasoline on the engine or exhaust system when refueling.
 - Never refuel while smoking or in the vicinity of an open flame.
 - Never start the engine or let it run for any length of time in a closed area. The exhaust fumes are poisonous and may cause loss of consciousness and death within a short time. Always operate your scooter in an area that has adequate ventilation.
 - Always turn the engine off before leaving the scooter unattended and remove the key from the main switch. When parking the scooter, note the following:
 - The engine and exhaust system may be hot, therefore, park the scooter in a place where pedestrians or children are not likely to touch these hot areas.
 - Do not park the scooter on a slope or soft ground, otherwise it may fall over.
 - Do not park the scooter near a flammable source (e.g., a kerosene heater, or near an open flame), otherwise it could catch fire.
 - If you should swallow any gasoline, inhale a lot of gasoline vapor, or allow gasoline to get into your eyes, see your doctor immediately. If any gasoline spills on your skin or clothing, immediately wash the affected area with soap and water and change your clothes.
- Be sure to signal clearly when making turns.
 - Braking can be extremely difficult on a wet road. Avoid hard braking, because the scooter could slide. Apply the brakes slowly when stopping on a wet surface.
 - Slow down as you approach a corner or turn. Once you have completed a turn, accelerate slowly.
 - Be careful when passing parked cars. A driver might not see you and open a door in your path.
 - Railroad crossings, streetcar rails, iron plates on road construction sites, and manhole covers become extremely slippery when wet. Slow down and cross them with caution. Keep the scooter upright, otherwise it could slide out from under you.
 - The brake pads could get wet when you wash the scooter. After washing the scooter, check the brakes before riding.
 - Always wear a helmet, gloves, trousers (tapered around the cuff

SAFETY INFORMATION

and ankle so they do not flap), and a bright colored jacket.

- Do not carry too much luggage on the scooter. An overloaded scooter is unstable.

DESCRIPTION

EAU10410

Left view

2

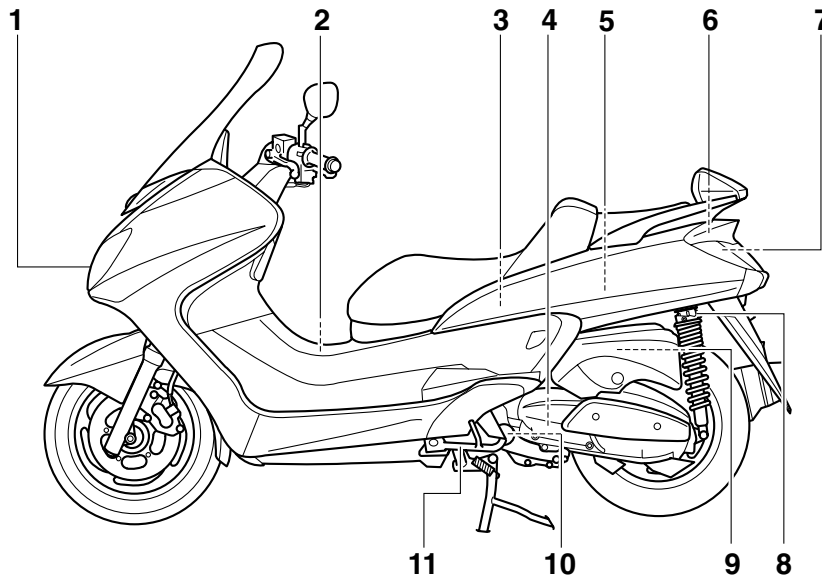

1. Headlight (page 6-34)
2. Fuel tank cap (page 3-12)
3. Rear storage compartment (page 3-16)
4. V-belt case air filter element (page 6-18)
5. Owner's tool kit (page 6-1)
6. Fuses (page 6-32)
7. Battery (page 6-30)
8. Shock absorber assembly spring preload adjusting ring (page 3-18)

9. Air filter element (left) (page 6-18)
10. Engine oil filter element (page 6-12)
11. Sidestand (page 3-19, 6-28)

Right view

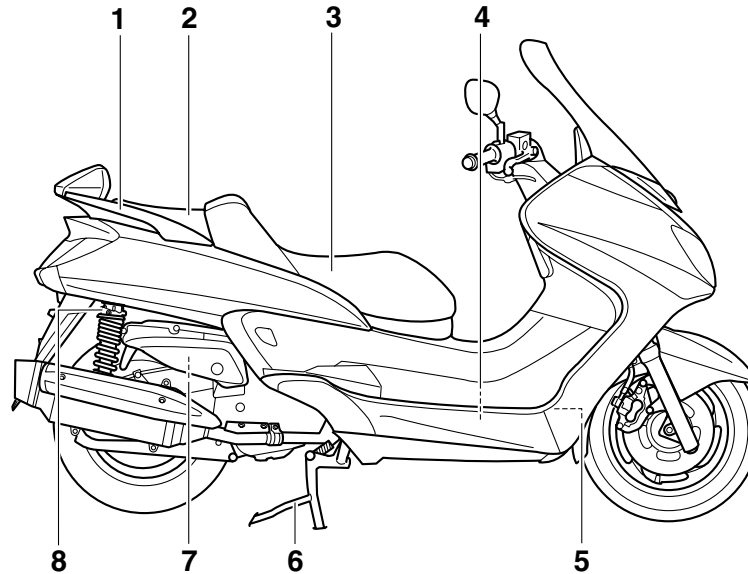

1. Grab bar (page 5-2)
2. Passenger seat (page 3-14)
3. Rider seat (page 3-14)
4. Coolant reservoir (page 6-16)
5. Radiator
6. Centerstand (page 6-28)
7. Air filter element (right) (page 6-18)
8. Shock absorber assembly spring preload adjusting ring (page 3-18)

DESCRIPTION

EAU10430

Controls and instruments

2

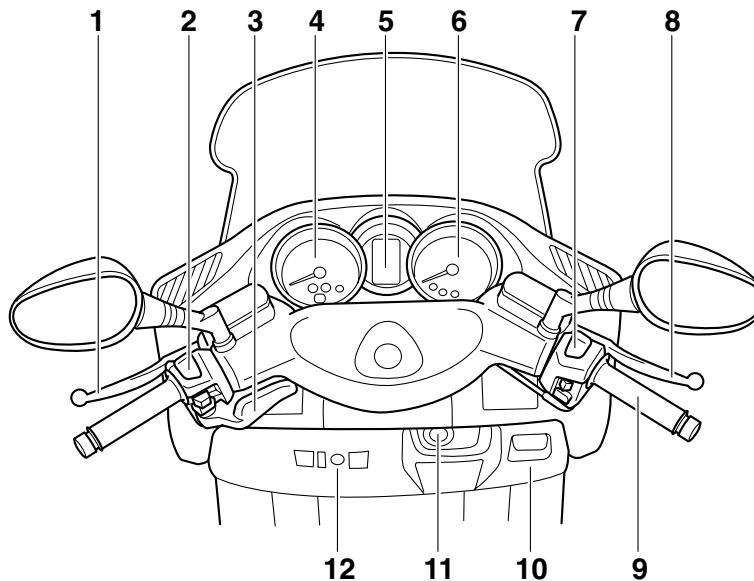

- 1. Rear brake lever (page 3-11)
- 2. Left handlebar switches (page 3-9)
- 3. Rear brake lock lever (page 3-11)
- 4. Speedometer (page 3-4)
- 5. Multi-function display (page 3-5)
- 6. Tachometer (page 3-5)
- 7. Right handlebar switches (page 3-9)
- 8. Front brake lever (page 3-10)

- 9. Throttle grip (page 6-20)
- 10. Front storage compartment B (page 3-16)
- 11. Main switch/steering lock (page 3-2)
- 12. Front storage compartment A (page 3-16)

Immobilizer system

EAU10972

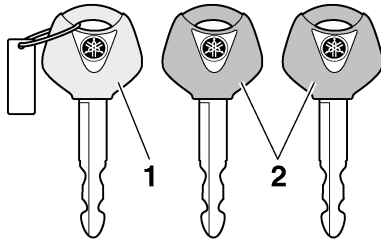

1. Code re-registering key (red bow)
2. Standard keys (black bow)

This vehicle is equipped with an immobilizer system to help prevent theft by re-registering codes in the standard keys. This system consists of the following.

- a code re-registering key (with a red bow)
- two standard keys (with a black bow) that can be re-registered with new codes
- a transponder (which is installed in the code re-registering key)
- an immobilizer unit
- an ECU

- an immobilizer system indicator light (See page 3-3.)
- The key with the red bow is used to register codes in each standard key. Since re-registering is a difficult process, take the vehicle along with all three keys to a Yamaha dealer to have them re-registered. Do not use the key with the red bow for driving. It should only be used for re-registering the standard keys. Always use a standard key for driving.

ECA11820

CAUTION:

- **DO NOT LOSE THE CODE RE-REGISTERING KEY! CONTACT YOUR DEALER IMMEDIATELY IF IT IS LOST!** If the code re-registering key is lost, registering new codes in the standard keys is impossible. The standard keys can still be used to start the vehicle, however if code re-registering is required (i.e., if a new standard key is made or all keys are lost) the entire immobilizer system must be replaced. Therefore, it is highly recommended to use either standard key and keep the code

re-registering key in a safe place.

- Do not submerge any key in water.
- Do not expose any key to excessively high temperatures.
- Do not place any key close to magnets (this includes, but not limited to, products such as speakers, etc.).
- Do not place heavy items on any key.
- Do not grind any key or alter its shape.
- Do not disassemble the plastic part of any key.
- Do not put two keys of any immobilizer system on the same key ring.
- Keep the standard keys as well as keys of other immobilizer systems away from this vehicle's code re-registering key.
- Keep other immobilizer system keys away from the main switch as they may cause signal interference.

INSTRUMENT AND CONTROL FUNCTIONS

Main switch/steering lock

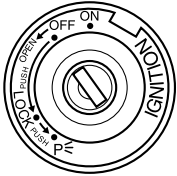

EAU10471

The main switch/steering lock controls the ignition and lighting systems, and is used to lock the steering.

NOTE:

Be sure to use the standard key (black bow) for regular use of the vehicle. To minimize the risk of losing the code re-registering key (red bow), keep it in a safe place and only use it for code re-registering.

EAU34121

ON

All electrical circuits are supplied with power; the meter lighting, taillight, license plate light and auxiliary lights

come on, and the engine can be started. The key cannot be removed.

NOTE:

The headlights come on automatically when the engine is started and stay on until the key is turned to “OFF” or the sidestand is moved down.

EAU10660

OFF

All electrical systems are off. The key can be removed.

EAU10680

LOCK

The steering is locked, and all electrical systems are off. The key can be removed.

To lock the steering

1. Turn the handlebars all the way to the left.
2. Push the key in from the “OFF” position, and then turn it to “LOCK” while still pushing it.
3. Remove the key.

To unlock the steering

Push the key in, and then turn it to “OFF” while still pushing it.

EWA10060

! WARNING

Never turn the key to “OFF” or “LOCK” while the vehicle is moving, otherwise the electrical systems will be switched off, which may result in loss of control or an accident. Make sure that the vehicle is stopped before turning the key to “OFF” or “LOCK”.

EAU10941

P<= (Parking)

The steering is locked, and the taillight, license plate light and auxiliary lights are on. The hazard lights and turn signal lights can be turned on, but all other electrical systems are off. The key can be removed.

The steering must be locked before the key can be turned to “P<=”.

ECA11020

CAUTION:

Do not use the parking position for an extended length of time, other-

INSTRUMENT AND CONTROL FUNCTIONS

wise the battery may discharge.

Indicator and warning lights

EAU11003

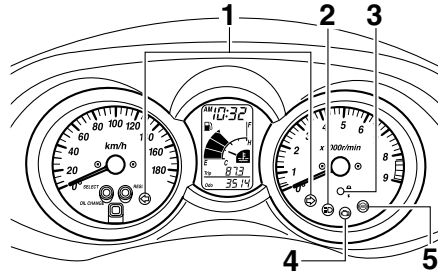

1. Turn signal indicator lights “” and “”
2. High beam indicator light “”
3. Immobilizer system indicator light
4. Engine trouble warning light “”
5. Anti-lock Brake System (ABS) warning light “” (for ABS models)

Turn signal indicator lights “” and “”

EAU11030

The corresponding indicator light flashes when the turn signal switch is pushed to the left or right.

High beam indicator light “”

EAU11080

This indicator light comes on when the

high beam of the headlight is switched on.

Engine trouble warning light “”

EAU11480

This warning light comes on when an electrical circuit monitoring the engine is defective. When this occurs, have a Yamaha dealer check the self-diagnosis system.

The electrical circuit of the warning light can be checked by turning the key to “ON”. If the warning light does not come on for a few seconds, then go off, have a Yamaha dealer check the electrical circuit.

ABS warning light “” (for ABS models)

EAU11551

ECA10830

CAUTION:

If the ABS warning light comes on or flashes while riding, the ABS may be defective. If this occurs, have a Yamaha dealer check the electrical circuit.

See page 3-12 for an explanation of the ABS.

INSTRUMENT AND CONTROL FUNCTIONS

The electrical circuit of the warning light can be checked by setting the engine stop switch to “○” and turning the key to “ON”. The warning light should come on for a few seconds, and then go off. If the warning light does not come on or remains on, have a Yamaha dealer check the electrical circuit.

EWA11350

3 **⚠ WARNING**

When the ABS warning light comes on or flashes while riding, the brake system reverts to conventional braking. Therefore, be careful not to cause the wheel to lock during emergency braking.

NOTE:

The ABS warning light may come on while pushing the start switch and while accelerating the engine with the scooter on its centerstand, but this does not indicate a malfunction.

EAU38620

Immobilizer system indicator light

The electrical circuit of the indicator light can be checked by turning the key

to “ON”.

If the indicator light does not come on for a few seconds, then go off, have a Yamaha dealer check the electrical circuit.

When the key is turned to “OFF” and 30 seconds have passed, the indicator light will start flashing indicating the immobilizer system is enabled. After 24 hours have passed, the indicator light will stop flashing, however the immobilizer system is still enabled.

This model is also equipped with a self-diagnosis device for the immobilizer system. (See page 3-5 for an explanation of the self-diagnosis device.)

Speedometer

EAU11601

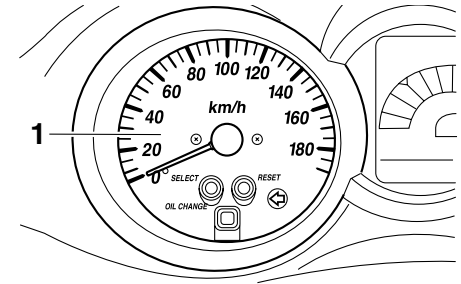

1. Speedometer

The speedometer shows the riding speed.

When the key is turned to “ON”, the speedometer needle will sweep once across the speed range and then return to zero in order to test the electrical circuit.

INSTRUMENT AND CONTROL FUNCTIONS

Tachometer

EAU11872

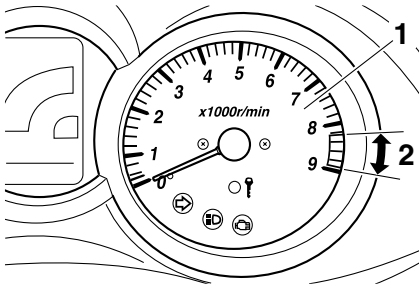

1. Tachometer
2. Tachometer red zone

The electric tachometer allows the rider to monitor the engine speed and keep it within the ideal power range.

When the key is turned to “ON”, the tachometer needle will sweep once across the r/min range and then return to zero r/min in order to test the electrical circuit.

CAUTION:

Do not operate the engine in the tachometer red zone.

Red zone: 8250 r/min and above

ECA10031

Multi-function display

EAU34136

EWA12311



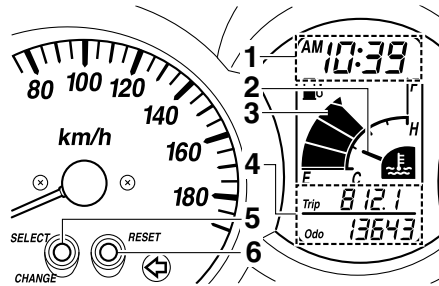

Be sure to stop the vehicle before making any setting changes to the multi-function display.

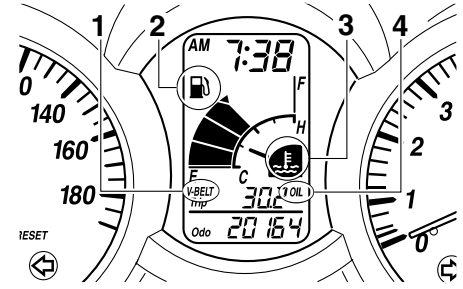

1. Clock/ambient temperature display
2. Coolant temperature meter
3. Fuel meter
4. Odometer/tripmeters
5. “SELECT” button
6. “RESET” button



1. V-belt replacement indicator “V-BELT”
2. Fuel level warning indicator “”
3. Coolant temperature warning indicator “”
4. Oil change indicator “OIL”

The multi-function display is equipped with the following:

- a fuel meter
- a coolant temperature meter
- an odometer (which shows the total distance traveled)
- two tripmeters (which show the distance traveled since they were last set to zero)
- a fuel reserve tripmeter (which shows the distance traveled since the bottom segment of the fuel meter and fuel level warning indi-

INSTRUMENT AND CONTROL FUNCTIONS

- cator started flashing)
- a self-diagnosis device
- a clock
- an ambient temperature display
- an oil change indicator
- a V-belt replacement indicator

NOTE: _____

- Be sure to turn the key to “ON” before using the “SELECT” and “RESET” buttons.
- When the key is turned to “ON”, all of the display segments of the multi-function display will appear one after the other and then disappear, in order to test the electrical circuit.

Odometer and tripmeter modes

Pushing the “SELECT” button switches the display between the odometer mode “ODO” and the tripmeter modes “TRIP” in the following order:

ODO → TRIP (top) → TRIP (bottom) → ODO

When approximately 2.8 L (0.74 US gal) (0.62 Imp.gal) of fuel remains in the fuel tank, the bottom segment of the fuel meter and fuel level warning indica-

tor will start flashing, and the display will automatically change to the fuel reserve tripmeter mode “TRIP F” and start counting the distance traveled from that point. In that case, pushing the “SELECT” button switches the display between the various tripmeter and odometer modes in the following order: TRIP F → TRIP (top) → TRIP (bottom) → ODO → TRIP F

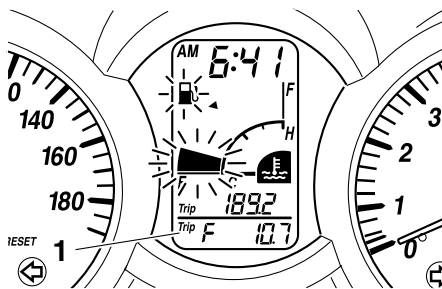

1. Fuel reserve tripmeter

To reset a tripmeter, select it by pushing the “SELECT” button until “TRIP” or “TRIP F” begins flashing (“TRIP” or “TRIP F” will only flash for five seconds). While “TRIP” or “TRIP F” is flashing, push the “RESET” button for at least one second. If you do not reset

the fuel reserve tripmeter manually, it will reset itself automatically and the display will return to the prior mode after refueling and traveling 5 km (3 mi).

NOTE: _____

The display cannot be changed back to “TRIP F” after pushing the “RESET” button.

Fuel meter

With the key in the “ON” position, the fuel meter indicates the amount of fuel in the fuel tank. The display segments of the fuel meter disappear towards “E” (Empty) as the fuel level decreases. When the fuel level reaches the bottom segment near “E”, the fuel level warning indicator and the bottom segment will flash. Refuel as soon as possible.

Coolant temperature meter

With the key in the “ON” position, the coolant temperature meter indicates the temperature of the coolant. The coolant temperature varies with changes in the weather and engine load. If the top segment and coolant temperature warning indicator flash, stop the

INSTRUMENT AND CONTROL FUNCTIONS

vehicle and let the engine cool. (See page 6-39.)

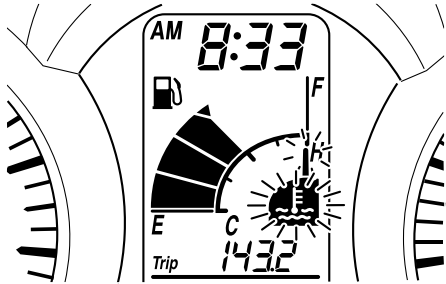

ECA10020

CAUTION:

Do not operate the engine if it is overheated.

Oil change indicator “OIL”

This indicator flashes at the initial 1000 km (600 mi), then at 5000 km (3000 mi) and every 5000 km (3000 mi) thereafter to indicate that the engine oil should be changed.

After changing the engine oil, reset the oil change indicator. (See page 6-12.) If the engine oil is changed before the oil change indicator comes on (i.e. before the periodic oil change interval has

been reached), the indicator must be reset after the oil change for the next periodic oil change to be indicated at the correct time. (See page 6-12.)

The electrical circuit of the indicator can be checked according to the following procedure.

1. Set the engine stop switch to “○” and turn the key to “ON”.
2. Check that the indicator comes on for a few seconds and then goes off.
3. If the indicator does not come on, have a Yamaha dealer check the electrical circuit.

NOTE:

The oil change indicator may flash when the engine is revved with the scooter on the centerstand, but this does not indicate a malfunction.

V-belt replacement indicator “V-BELT”

This indicator flashes every 20000 km (12500 mi) when the V-belt needs to be replaced.

The electrical circuit of the indicator can be checked according to the following

procedure.

1. Turn the key to “ON” and make sure that the engine stop switch is set to “○”.
2. If the indicator does not come on, have a Yamaha dealer check the electrical circuit.

Self-diagnosis device

This model is equipped with a self-diagnosis device for various electrical circuits.

If any of those circuits are defective, the multi-function display will indicate a two-digit error code.

If the multi-function display indicates such an error code, note the code number, and then have a Yamaha dealer check the vehicle.

ECA11790

CAUTION:

If the multi-function display indicates an error code, the vehicle should be checked as soon as possible in order to avoid engine damage.

This model is also equipped with a self-diagnosis device for the immobiliz-

INSTRUMENT AND CONTROL FUNCTIONS

er system.

If any of the immobilizer system circuits are defective, the immobilizer system indicator light will flash, and then the multi-function display will indicate a two-digit error code when the key is turned to “ON”.

NOTE: _____

If the multi-function display indicates error code 52, this could be caused by transponder interference. If this error appears, try the following.

1. Use the code re-registering key to start the engine.

NOTE: _____

Make sure there are no other immobilizer keys close to the main switch, and do not keep more than one immobilizer key on the same key ring! Immobilizer system keys may cause signal interference, which may prevent the engine from starting.

2. If the engine starts, turn it off, and try starting the engine with the standard keys.
3. If one or both of the standard keys do not start the engine, take the

vehicle, the code re-registering key and both standard keys to a Yamaha dealer and have the standard keys re-registered.

If the multi-function display indicates any error codes, note the code number, and then have a Yamaha dealer check the vehicle.

Clock mode

To set the clock:

1. Push the “SELECT” button and “RESET” button together for at least two seconds.
2. When the hour digits start flashing, push the “RESET” button to set the hours.
3. Push the “SELECT” button, and the minute digits will start flashing.
4. Push the “RESET” button to set the minutes.
5. Push the “SELECT” button and then release it to start the clock. Pushing the “SELECT” button for at least two seconds switches the clock display to the ambient temperature display.

Ambient temperature display

This display shows the ambient temperature from $-10\text{ }^{\circ}\text{C}$ to $50\text{ }^{\circ}\text{C}$ in $1\text{ }^{\circ}\text{C}$ increments. The temperature displayed may vary from the ambient temperature. Pushing the “SELECT” button for at least two seconds switches the ambient temperature display to the clock display.

NOTE: _____

- If the ambient temperature falls below $-10\text{ }^{\circ}\text{C}$, a lower temperature than $-10\text{ }^{\circ}\text{C}$ will not be displayed.
- If the ambient temperature climbs above $50\text{ }^{\circ}\text{C}$, a higher temperature than $50\text{ }^{\circ}\text{C}$ will not be displayed.
- The accuracy of the temperature reading may be affected when riding slowly (approximately under 20 km/h (12.5 mi/h)) or when stopped at traffic signals, railroad crossings, etc.

INSTRUMENT AND CONTROL FUNCTIONS

Anti-theft alarm (optional)

This model can be equipped with an optional anti-theft alarm by a Yamaha dealer. Contact a Yamaha dealer for more information.

EAU12331

Handlebar switches

EAU12347

Left

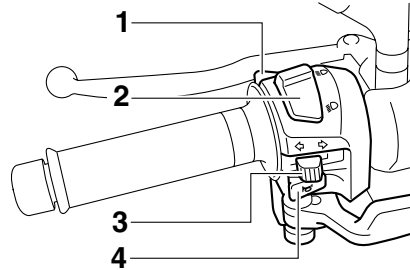

1. Pass switch "PASS"
2. Dimmer switch "≡○/≡○"
3. Turn signal switch "↔/↔"
4. Horn switch "🔊"

Right

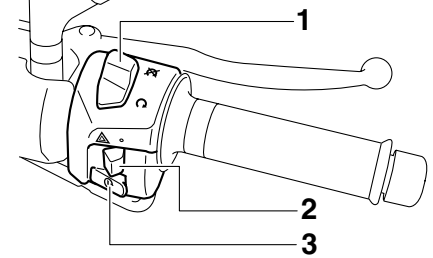

1. Engine stop switch "○/⊗"
2. Hazard switch "△"
3. Start switch "⊚"

3

EAU12360

Pass switch "PASS"

Press this switch to flash the headlight.

EAU12400

Dimmer switch "≡○/≡○"

Set this switch to "≡○" for the high beam and to "≡○" for the low beam.

EAU12460

Turn signal switch "↔/↔"

To signal a right-hand turn, push this switch to "↔". To signal a left-hand turn, push this switch to "↔". When re-

INSTRUMENT AND CONTROL FUNCTIONS

leased, the switch returns to the center position. To cancel the turn signal lights, push the switch in after it has returned to the center position.



EAU12500

Horn switch “”

Press this switch to sound the horn.

EAU12660

Engine stop switch “”

Set this switch to “” before starting the engine. Set this switch to “” to stop the engine in case of an emergency, such as when the vehicle overturns or when the throttle cable is stuck.

EAU12720

Start switch “”

With the sidestand up, push this switch while applying the front or rear brake to crank the engine with the starter.

ECA10050

CAUTION:

See page 5-1 for starting instructions prior to starting the engine.

EAU42810

(for ABS models)

The engine trouble warning light and ABS warning light will come on when the key is turned to “ON” and the start switch is pushed, but this does not indicate a malfunction.

EAU12733

Hazard switch “”

With the key in the “ON” or “P<” position, use this switch to turn on the hazard lights (simultaneous flashing of all turn signal lights).

The hazard lights are used in case of an emergency or to warn other drivers when your vehicle is stopped where it might be a traffic hazard.

ECA10061

CAUTION:

Do not use the hazard lights for an extended length of time with the engine not running, otherwise the battery may discharge.

EAU12900

Front brake lever

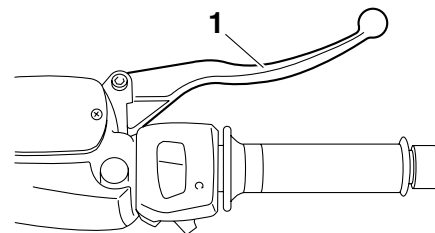

1. Front brake lever

The front brake lever is located on the right handlebar grip. To apply the front brake, pull this lever toward the handlebar grip.

INSTRUMENT AND CONTROL FUNCTIONS

Rear brake lever

EAU12950

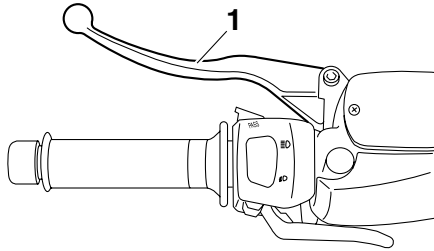

1. Rear brake lever

The rear brake lever is located on the left handlebar grip. To apply the rear brake, pull this lever toward the handlebar grip.

Rear brake lock lever

EAU12962

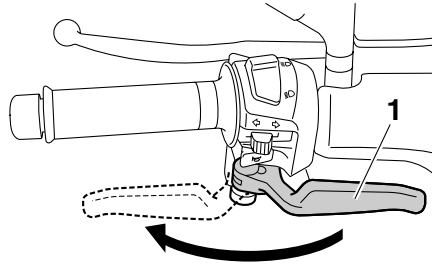

1. Rear brake lock lever

This vehicle is equipped with a rear brake lock lever to prevent the rear wheel from moving while stopped at traffic signals, railroad crossings, etc.

To lock the rear wheel

Push the rear brake lock lever to the left until it snaps into place.

To unlock the rear wheel

Push the rear brake lock lever back to the original position.

NOTE: _____

- Be sure to check that the rear wheel does not move when the

rear brake lock lever is applied.

- To provide secure locking of the rear wheel, apply the rear brake lever first before moving the rear brake lock lever to the left.

EWA12361

⚠ WARNING

Never move the rear brake lock lever to the left while the vehicle is moving, otherwise loss of control or an accident may result. Make sure that the vehicle is stopped before moving the rear brake lock lever to the left.

INSTRUMENT AND CONTROL FUNCTIONS

EAU12991

ABS (for ABS models)

The Yamaha ABS (Anti-lock Brake System) features a dual electronic control system, which acts on the front and rear brakes independently. The ABS securely controls wheel lockup during emergency braking on changing road surfaces and under various weather conditions, thereby maximizing tire adhesion and performance while providing a smooth braking action. The ABS is monitored by an ECU (Electronic Control Unit), which will have recourse to manual braking if a malfunction occurs.

EWA10090

WARNING

- **The ABS performs best on long braking distances.**
- **On certain (rough or gravel) roads, the braking distance may be longer with than without the ABS. Therefore, always keep a sufficient distance to the vehicle ahead to match the riding speed.**

NOTE: _____

- When the ABS is activated, the brakes are operated in the usual way. A pulsating action may be felt at the brake levers, but this does not indicate a malfunction.
- This ABS has a test mode which allows the owner to experience the pulsating at the brake levers when the ABS is operating. However, special tools are required, so please consult your Yamaha dealer when performing this test.

EAU13161

Fuel tank cap

To open the fuel tank cap

1. Open the lid by sliding the lever forward, and then pull the lever up.

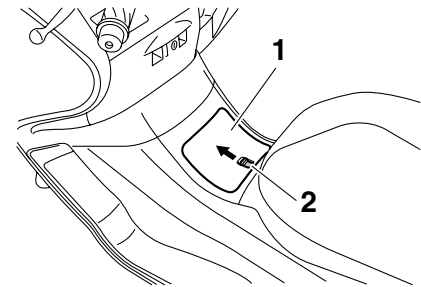

1. Lid
2. Opening lever

2. Insert the key into the lock and turn it clockwise. The lock will be released and the fuel tank cap can be removed.

INSTRUMENT AND CONTROL FUNCTIONS

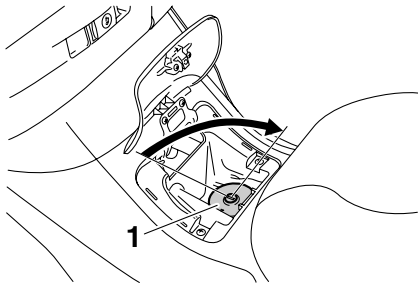

1. Fuel tank cap

To install the fuel tank cap

1. Align the match marks, insert the fuel tank cap into the tank opening, and then push down on the cap.

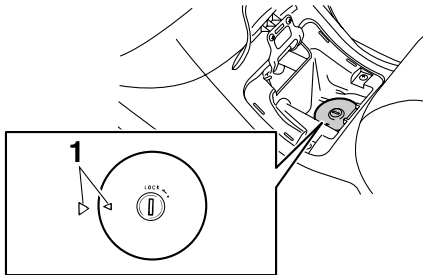

1. Match marks

2. Turn the key counterclockwise to the original position, and then re-

- move it.
3. Close the lid.

EWA11120

! WARNING

Be sure that the fuel tank cap is properly installed and locked before riding the scooter.

Fuel

EAU13211

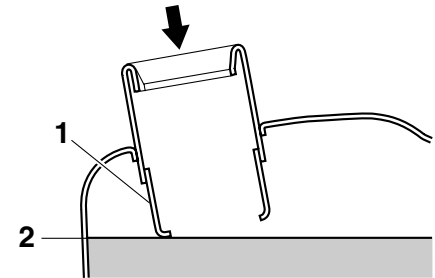

1. Fuel tank filler tube
2. Fuel level

Make sure that there is sufficient fuel in the tank. Fill the fuel tank to the bottom of the filler tube as shown.

EWA10880

! WARNING

- Do not overfill the fuel tank, otherwise it may overflow when the fuel warms up and expands.
- Avoid spilling fuel on the hot engine.

ECA10070

CAUTION:

Immediately wipe off spilled fuel with a clean, dry, soft cloth, since

INSTRUMENT AND CONTROL FUNCTIONS

fuel may deteriorate painted surfaces or plastic parts.

EAU33520

Recommended fuel:
REGULAR UNLEADED GASOLINE
ONLY
Fuel tank capacity:
14.0 L (3.70 US gal) (3.08 Imp.gal)

ECA11400

CAUTION:

Use only unleaded gasoline. The use of leaded gasoline will cause severe damage to internal engine parts, such as the valves and piston rings, as well as to the exhaust system.

Your Yamaha engine has been designed to use regular unleaded gasoline with a research octane number of 91 or higher. If knocking (or pinging) occurs, use a gasoline of a different brand or premium unleaded fuel. Use of unleaded fuel will extend spark plug life and reduce maintenance costs.

Catalytic converter

EAU13441

This vehicle is equipped with catalytic converters in the exhaust system.

EWA10860

WARNING

The exhaust system is hot after operation. Make sure that the exhaust system has cooled down before doing any maintenance work.

ECA10700

CAUTION:

The following precautions must be observed to prevent a fire hazard or other damages.

- Use only unleaded gasoline. The use of leaded gasoline will cause unreparable damage to the catalytic converter.
- Never park the vehicle near possible fire hazards such as grass or other materials that easily burn.
- Do not allow the engine to idle too long.

Seats

EAU34140

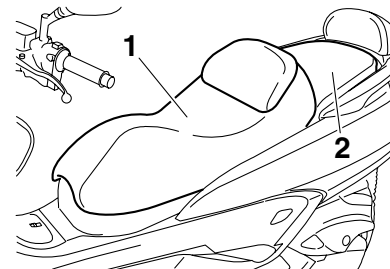

1. Rider seat
2. Passenger seat

Rider seat

To open the rider seat

1. Place the scooter on the center-stand.
2. Insert the key into the main switch, and then turn it counterclockwise.

INSTRUMENT AND CONTROL FUNCTIONS

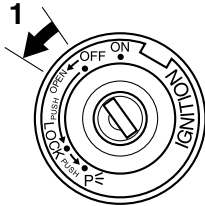

1. Open.

NOTE: _____
Do not push inward when turning the key.

3. Fold the rider seat up.

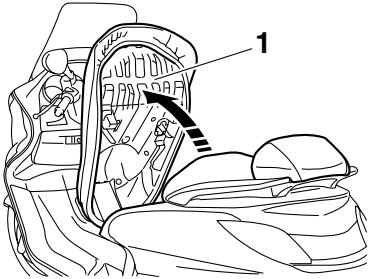

1. Rider seat

To close the rider seat

1. Fold the rider seat down, and then push it down to lock it in place.
2. Remove the key from the main switch if the scooter will be left unattended.

NOTE: _____
Make sure that the rider seat is properly secured before riding.

Passenger seat

To remove the passenger seat

1. Open the rider seat.
2. Remove the bolt, and then pull the passenger seat forward.

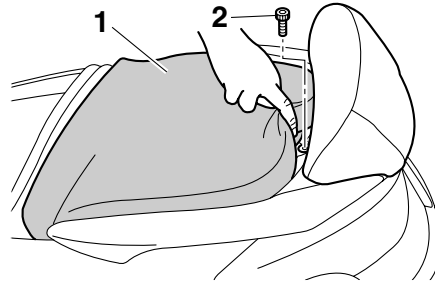

1. Passenger seat
2. Bolt

To install the passenger seat

1. Insert the projections on the passenger seat into the holders as shown, place the passenger seat in the original position, and then install the bolt.

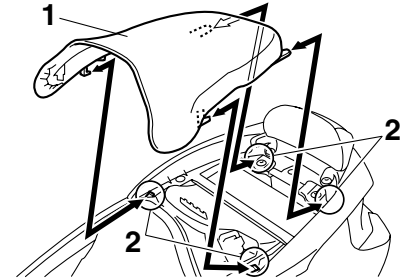

1. Passenger seat
2. Seat holder

2. Close the rider seat.

NOTE: _____
Make sure that the passenger seat is properly secured before riding.

INSTRUMENT AND CONTROL FUNCTIONS

EAU34150

Adjusting the rider seat

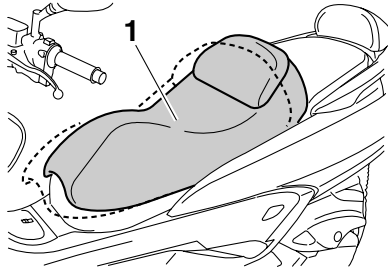

1. Rider seat

The rider seat can be adjusted as follows to change the riding position.

1. Open the rider seat. (See page 3-14.)
2. Remove the bolts.

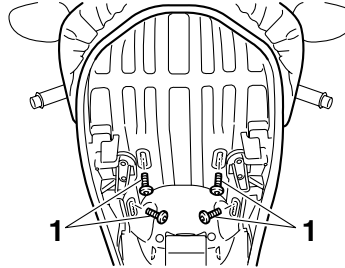

1. Bolt

3. Slide the rider seat forward or backward to the desired position.
4. Install bolts and securely tighten them.
5. Close the rider seat.

EAU14492

Storage compartments

Front storage compartment A

To open the storage compartment when it is locked, insert the key in the lock, turn it counterclockwise, and then grasp the lock while pushing the button in.

To open the storage compartment when it is unlocked, simply grasp the lock while pushing the button in.

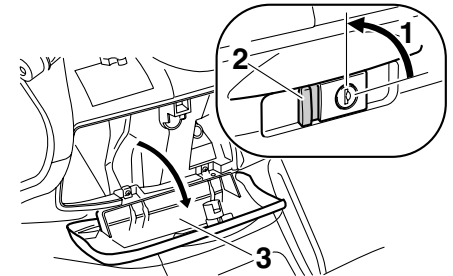

1. Open.
2. Button
3. Lid

To lock the storage compartment, push the lid into the original position, insert the key in the lock, turn it clockwise,

INSTRUMENT AND CONTROL FUNCTIONS

and then remove it.

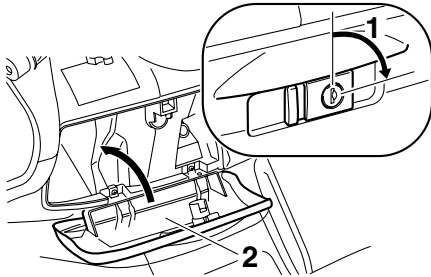

1. Lock.
2. Lid

Front storage compartment B

To open the storage compartment, slide the lever up, and then pull on the lever.

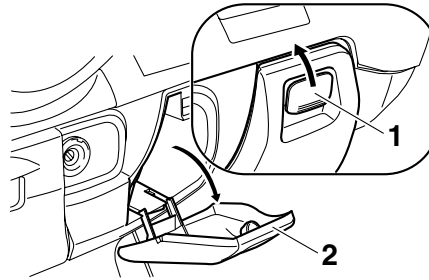

1. Storage compartment opening lever
2. Lid

To close the storage compartment, push the lid into the original position.

EWA11160



Do not store heavy items in this compartment.

Rear storage compartment

Two helmets can be stored in the storage compartment under the seats. (See page 3-14.)

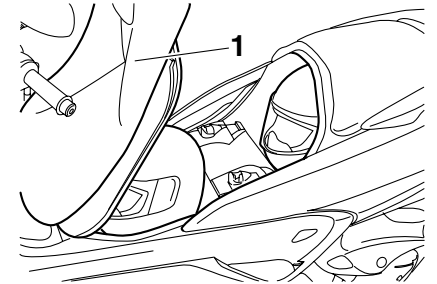

1. Rider seat

ECA10080

CAUTION:

Keep the following points in mind when using the storage compartment.

- Since the storage compartment accumulates heat when exposed to the sun, do not store anything susceptible to heat inside it.
- To avoid humidity from spreading through the storage compartment, wrap wet articles in a plastic bag before storing them in the compartment.
- Since the storage compartment may get wet while the scooter is

INSTRUMENT AND CONTROL FUNCTIONS

being washed, wrap any articles stored in the compartment in a plastic bag.

- Do not keep anything valuable or breakable in the storage compartment.

ECA11170

CAUTION:

3

Do not leave the rider seat open for an extended period of time, otherwise the light may cause the battery to discharge.

EWA11170

WARNING

Do not exceed the following loading limits:

- Front storage compartment A: 2 kg (4 lb)
- Rear storage compartment: 5 kg (11 lb)
- Maximum load for the vehicle: YP400 189 kg (417 lb)/YP400A 185 kg (408 lb)

ECA10100

Adjusting the shock absorber assemblies

EAU14890

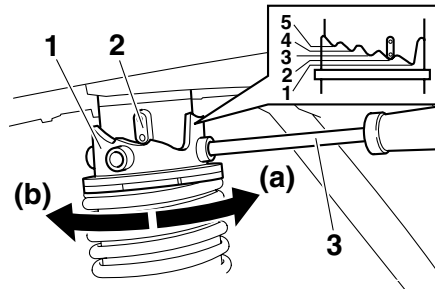

1. Spring preload adjusting ring
2. Position indicator
3. Spring preload adjusting tool

Each shock absorber assembly is equipped with a spring preload adjusting ring.

CAUTION:

Never attempt to turn an adjusting mechanism beyond the maximum or minimum settings.

EWA10210

WARNING

Always adjust both shock absorber assemblies equally, otherwise poor

handling and loss of stability may result.

Adjust the spring preload as follows. To increase the spring preload and thereby harden the suspension, turn the adjusting ring on each shock absorber assembly in direction (a). To decrease the spring preload and thereby soften the suspension, turn the adjusting ring on each shock absorber assembly in direction (b).

NOTE:

- Align the appropriate notch in the adjusting ring with the position indicator on the shock absorber.
- Use the spring preload adjusting tool included in the owner's tool kit to make this adjustment.

Spring preload setting:

Minimum (soft):

1

Standard:

2

Maximum (hard):

5

EAU15301

Sidestand

The sidestand is located on the left side of the frame. Raise the sidestand or lower it with your foot while holding the vehicle upright.

NOTE:

The built-in sidestand switch is part of the ignition circuit cut-off system, which cuts the ignition in certain situations. (See further down for an explanation of the ignition circuit cut-off system.)

EWA10240

WARNING

The vehicle must not be ridden with the sidestand down, or if the sidestand cannot be properly moved up (or does not stay up), otherwise the sidestand could contact the ground and distract the operator, resulting in a possible loss of control. Yamaha's ignition circuit cut-off system has been designed to assist the operator in fulfilling the responsibility of raising the sidestand before starting off. Therefore, check this system regularly as described below and have a Yamaha dealer re-

pair it if it does not function properly.

EAU15371

Ignition circuit cut-off system

The ignition circuit cut-off system (comprising the sidestand switch and brake light switches) has the following functions.

- It prevents starting when the sidestand is up, but neither brake is applied.
- It prevents starting when either brake is applied, but the sidestand is still down.
- It cuts the running engine when the sidestand is moved down.

Periodically check the operation of the ignition circuit cut-off system according to the following procedure.

EWA10250

WARNING

If a malfunction is noted, have a Yamaha dealer check the system before riding.

INSTRUMENT AND CONTROL FUNCTIONS

3

With the engine turned off:
1. Move the sidestand down.
2. Make sure that the engine stop switch is turned on.
3. Turn the key on.
4. Keep the front or rear brake applied.
5. Push the start switch.
Does the engine start?

NO YES

NOTE:
This check is most reliable if performed with a warmed-up engine.

The sidestand switch may be defective.
The scooter should not be ridden until checked by a Yamaha dealer.

With the engine still off:
6. Move the sidestand up.
7. Keep the front or rear brake applied.
8. Push the start switch.
Does the engine start?

YES NO

The brake switch may be defective.
The scooter should not be ridden until checked by a Yamaha dealer.

With the engine still running:
9. Move the sidestand down.
Does the engine stall?

YES NO

The sidestand switch may be defective.
The scooter should not be ridden until checked by a Yamaha dealer.

The system is OK. **The scooter can be ridden.**

PRE-OPERATION CHECKS

EAU15591

The condition of a vehicle is the owner's responsibility. Vital components can start to deteriorate quickly and unexpectedly, even if the vehicle remains unused (for example, as a result of exposure to the elements). Any damage, fluid leakage or loss of tire air pressure could have serious consequences. Therefore, it is very important, in addition to a thorough visual inspection, to check the following points before each ride.

NOTE:

Pre-operation checks should be made each time the vehicle is used. Such an inspection can be accomplished in a very short time; and the added safety it assures is more than worth the time involved.

EWA11150



If any item in the Pre-operation check list is not working properly, have it inspected and repaired before operating the vehicle.

PRE-OPERATION CHECKS

EAU15605

Pre-operation check list

ITEM	CHECKS	PAGE
Fuel	<ul style="list-style-type: none">• Check fuel level in fuel tank.• Refuel if necessary.• Check fuel line for leakage.	3-13
Engine oil	<ul style="list-style-type: none">• Check oil level in engine.• If necessary, add recommended oil to specified level.• Check vehicle for oil leakage.	6-12
Final transmission oil	<ul style="list-style-type: none">• Check vehicle for oil leakage.	6-15
Coolant	<ul style="list-style-type: none">• Check coolant level in reservoir.• If necessary, add recommended coolant to specified level.• Check cooling system for leakage.	6-16
Front brake	<ul style="list-style-type: none">• Check operation.• If soft or spongy, have Yamaha dealer bleed hydraulic system.• Check brake pads for wear.• Replace if necessary.• Check fluid level in reservoir.• If necessary, add recommended brake fluid to specified level.• Check hydraulic system for leakage.	6-25
Rear brake	<ul style="list-style-type: none">• Check operation.• If soft or spongy, have Yamaha dealer bleed hydraulic system.• Check brake pads for wear.• Replace if necessary.• Check fluid level in reservoir.• If necessary, add recommended brake fluid to specified level.• Check hydraulic system for leakage.	6-25
Throttle grip	<ul style="list-style-type: none">• Make sure that operation is smooth.• Check cable free play.• If necessary, have Yamaha dealer adjust cable free play and lubricate cable and grip housing.	6-20, 6-27

4

PRE-OPERATION CHECKS

ITEM	CHECKS	PAGE
Wheels and tires	<ul style="list-style-type: none">• Check for damage.• Check tire condition and tread depth.• Check air pressure.• Correct if necessary.	6-21, 6-23
Brake levers	<ul style="list-style-type: none">• Make sure that operation is smooth.• Lubricate lever pivoting points if necessary.	6-28
Centerstand, sidestand	<ul style="list-style-type: none">• Make sure that operation is smooth.• Lubricate pivots if necessary.	6-28
Chassis fasteners	<ul style="list-style-type: none">• Make sure that all nuts, bolts and screws are properly tightened.• Tighten if necessary.	—
Instruments, lights, signals and switches	<ul style="list-style-type: none">• Check operation.• Correct if necessary.	—
Sidestand switch	<ul style="list-style-type: none">• Check operation of ignition circuit cut-off system.• If system is defective, have Yamaha dealer check vehicle.	3-19

OPERATION AND IMPORTANT RIDING POINTS

EAU15980

EWA10870

WARNING

- Become thoroughly familiar with all operating controls and their functions before riding. Consult a Yamaha dealer regarding any control or function that you do not thoroughly understand.
 - Never start the engine or operate it in a closed area for any length of time. Exhaust fumes are poisonous, and inhaling them can cause loss of consciousness and death within a short time. Always make sure that there is adequate ventilation.
 - For safety, always start the engine with the centerstand down.
-

Starting the engine

EAU34460

ECA10250

CAUTION:

See page 5-4 for engine break-in instructions prior to operating the vehicle for the first time.

In order for the ignition circuit cut-off system to enable starting, the side-stand must be up.

EWA10290

WARNING

- Before starting the engine, check the function of the ignition circuit cut-off system according to the procedure described on page 3-19.
 - Never ride with the sidestand down.
-

1. Turn the key to “ON” and make sure that the engine stop switch is set to “○”.
2. Close the throttle completely.
3. Start the engine by pushing the start switch while applying the front or rear brake.

NOTE:

If the engine does not start, release the

start switch, wait a few seconds, and then try again. Each starting attempt should be as short as possible to preserve the battery. Do not crank the engine more than 10 seconds on any one attempt.

ECA11040

CAUTION:

For maximum engine life, never accelerate hard when the engine is cold!

OPERATION AND IMPORTANT RIDING POINTS

EAU16760

Starting off

NOTE:

Before starting off, allow the engine to warm up.

1. While pulling the rear brake lever with your left hand and holding the grab bar with your right hand, push the scooter off the centerstand.

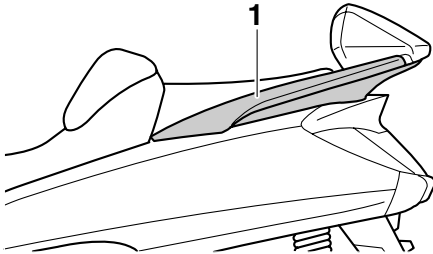

1. Grab bar

2. Sit astride the seat, and then adjust the rear view mirrors.
3. Switch the turn signal on.
4. Check for oncoming traffic, and then slowly turn the throttle grip (on the right) in order to take off.
5. Switch the turn signal off.

EAU16780

Acceleration and deceleration

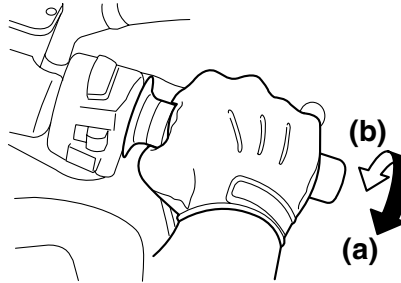

The speed can be adjusted by opening and closing the throttle. To increase the speed, turn the throttle grip in direction (a). To reduce the speed, turn the throttle grip in direction (b).

EAU16791

Braking

1. Close the throttle completely.
2. Apply both front and rear brakes simultaneously while gradually increasing the pressure.

Front

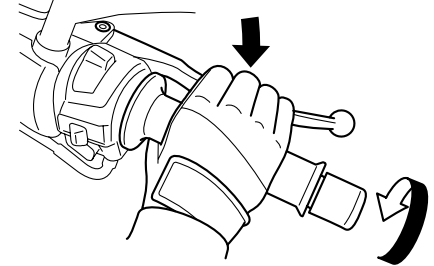

OPERATION AND IMPORTANT RIDING POINTS

Rear

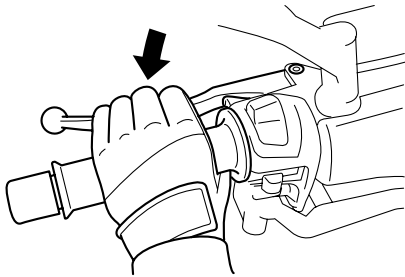

EWA10300

WARNING

- Avoid braking hard or suddenly (especially when leaning over to one side), otherwise the scooter may skid or overturn.
- Railroad crossings, streetcar rails, iron plates on road construction sites, and manhole covers become extremely slippery when wet. Therefore, slow down when approaching such areas and cross them with caution.
- Keep in mind that braking on a wet road is much more difficult.
- Ride slowly down a hill, as braking downhill can be very diffi-

cult.

EAU16820

Tips for reducing fuel consumption

Fuel consumption depends largely on your riding style. Consider the following tips to reduce fuel consumption:

- Avoid high engine speeds during acceleration.
- Avoid high engine speeds with no load on the engine.
- Turn the engine off instead of letting it idle for an extended length of time (e.g., in traffic jams, at traffic lights or at railroad crossings).

OPERATION AND IMPORTANT RIDING POINTS

Engine break-in

EAU16841

There is never a more important period in the life of your engine than the period between 0 and 1600 km (1000 mi). For this reason, you should read the following material carefully.

Since the engine is brand new, do not put an excessive load on it for the first 1600 km (1000 mi). The various parts in the engine wear and polish themselves to the correct operating clearances. During this period, prolonged full-throttle operation or any condition that might result in engine overheating must be avoided.

EAU34320

0–1000 km (0–600 mi)

Avoid prolonged operation above 4000 r/min.

1000–1600 km (600–1000 mi)

Avoid prolonged operation above 6000 r/min.

ECA12930

CAUTION:

After 1000 km (600 mi) of operation,

be sure to replace the engine oil, final transmission oil and the oil filter element.

1600 km (1000 mi) and beyond

The vehicle can now be operated normally.

ECA10310

CAUTION:

- Keep the engine speed out of the tachometer red zone.
- If any engine trouble should occur during the engine break-in period, immediately have a Yamaha dealer check the vehicle.

EAU17212

Parking

When parking, stop the engine, and then remove the key from the main switch.

EWA10310

WARNING

- Since the engine and exhaust system can become very hot, park in a place where pedestrians or children are not likely to touch them.
- Do not park on a slope or on soft ground, otherwise the vehicle may overturn.

ECA10380

CAUTION:

Never park in an area where there are fire hazards such as grass or other flammable materials.

PERIODIC MAINTENANCE AND MINOR REPAIR

EAU17280

Safety is an obligation of the owner. Periodic inspection, adjustment and lubrication will keep your vehicle in the safest and most efficient condition possible. The most important points of inspection, adjustment, and lubrication are explained on the following pages.

The intervals given in the periodic maintenance and lubrication chart should be simply considered as a general guide under normal riding conditions. However, DEPENDING ON THE WEATHER, TERRAIN, GEOGRAPHICAL LOCATION, AND INDIVIDUAL USE, THE MAINTENANCE INTERVALS MAY NEED TO BE SHORTENED.

EWA10320

⚠ WARNING

If you are not familiar with maintenance work, have a Yamaha dealer do it for you.

EWA10330

⚠ WARNING

This scooter is designed for use on paved roads only. If this scooter is

operated in abnormally dusty, muddy or wet conditions, the air filter element should be cleaned or replaced more frequently, otherwise rapid engine wear may result. Consult a Yamaha dealer for proper maintenance intervals.

EAU17501

Owner's tool kit

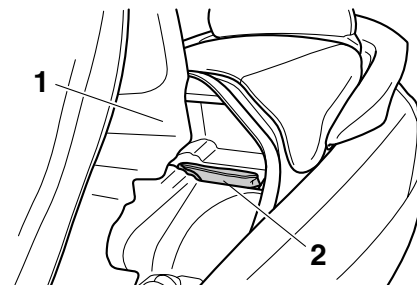

1. Storage compartment mat
2. Owner's tool kit

The owner's tool kit is located inside the rear storage compartment. (See page 3-16.)

Pull up the storage compartment mat, and then remove the owner's tool kit.

The service information included in this manual and the tools provided in the owner's tool kit are intended to assist you in the performance of preventive maintenance and minor repairs. However, additional tools such as a torque wrench may be necessary to perform certain maintenance work correctly.

PERIODIC MAINTENANCE AND MINOR REPAIR

NOTE: _____

If you do not have the tools or experience required for a particular job, have a Yamaha dealer perform it for you.

EWA10350



Modifications not approved by Yamaha may cause loss of performance and render the vehicle unsafe for use. Consult a Yamaha dealer before attempting any changes.

PERIODIC MAINTENANCE AND MINOR REPAIR

EAU17705

Periodic maintenance and lubrication chart

NOTE:

- The annual checks must be performed every year, except if a kilometer-based maintenance is performed instead.
- From 50000 km, repeat the maintenance intervals starting from 10000 km.
- Items marked with an asterisk should be performed by a Yamaha dealer as they require special tools, data and technical skills.

NO.	ITEM	CHECK OR MAINTENANCE JOB	ODOMETER READING (× 1000 km)					ANNUAL CHECK
			1	10	20	30	40	
1	* Fuel line	<ul style="list-style-type: none"> ● Check fuel hoses for cracks or damage. 		√	√	√	√	√
2	Spark plug	<ul style="list-style-type: none"> ● Check condition. ● Clean and regap. 		√		√		
		<ul style="list-style-type: none"> ● Replace. 			√		√	
3	* Valves	<ul style="list-style-type: none"> ● Check valve clearance. ● Adjust. 	Every 40000 km					
4	Air filter elements	<ul style="list-style-type: none"> ● Replace. 			√		√	
5	V-belt case air filter element	<ul style="list-style-type: none"> ● Clean. 		√	√	√	√	
6	* Front brake	<ul style="list-style-type: none"> ● Check operation, fluid level and vehicle for fluid leakage. 	√	√	√	√	√	√
		<ul style="list-style-type: none"> ● Replace brake pads. 	Whenever worn to the limit					
7	* Rear brake	<ul style="list-style-type: none"> ● Check operation, fluid level and vehicle for fluid leakage. 	√	√	√	√	√	√
		<ul style="list-style-type: none"> ● Replace brake pads. 	Whenever worn to the limit					
8	Rear brake lock	<ul style="list-style-type: none"> ● Check operation. ● Adjust. 	√	√	√	√	√	√
9	* Brake hoses	<ul style="list-style-type: none"> ● Check for cracks or damage. 		√	√	√	√	√
		<ul style="list-style-type: none"> ● Replace. 	Every 4 years					

PERIODIC MAINTENANCE AND MINOR REPAIR

NO.	ITEM	CHECK OR MAINTENANCE JOB	ODOMETER READING (× 1000 km)					ANNUAL CHECK
			1	10	20	30	40	
10	* Wheels	<ul style="list-style-type: none"> • Check runout and for damage. 		√	√	√	√	
11	* Tires	<ul style="list-style-type: none"> • Check tread depth and for damage. • Replace if necessary. • Check air pressure. • Correct if necessary. 		√	√	√	√	√
12	* Wheel bearings	<ul style="list-style-type: none"> • Check bearing for looseness or damage. 		√	√	√	√	
13	* Steering bearings	<ul style="list-style-type: none"> • Check bearing play and steering for roughness. • Lubricate with lithium-soap-based grease. 	√	√	√	√	√	
14	* Chassis fasteners	<ul style="list-style-type: none"> • Make sure that all nuts, bolts and screws are properly tightened. 		√	√	√	√	√
15	Sidestand, centerstand	<ul style="list-style-type: none"> • Check operation. • Lubricate. 		√	√	√	√	√
16	* Sidestand switch	<ul style="list-style-type: none"> • Check operation. 	√	√	√	√	√	√
17	* Front fork	<ul style="list-style-type: none"> • Check operation and for oil leakage. 		√	√	√	√	
18	* Shock absorber assemblies	<ul style="list-style-type: none"> • Check operation and shock absorbers for oil leakage. 		√	√	√	√	
19	* Fuel injection	<ul style="list-style-type: none"> • Check engine idle speed. 	√	√	√	√	√	√
20	Engine oil	<ul style="list-style-type: none"> • Change. (See pages 3-5 and 6-12.) 	√	When the oil change indicator flashes (every 5000 km)				
		<ul style="list-style-type: none"> • Check oil level and vehicle for oil leakage. 	Every 5000 km					√
21	Engine oil filter element	<ul style="list-style-type: none"> • Replace. 	√		√		√	
22	* Cooling system	<ul style="list-style-type: none"> • Check coolant level and vehicle for coolant leakage. 		√	√	√	√	√
		<ul style="list-style-type: none"> • Change. 	Every 3 years					
23	Final transmission oil	<ul style="list-style-type: none"> • Check vehicle for oil leakage. 	√	√		√		
		<ul style="list-style-type: none"> • Change. 	√	√	√	√	√	√
24	* V-belt	<ul style="list-style-type: none"> • Replace. 	When the V-belt replacement indicator flashes (every 20000 km)					
25	* Front and rear brake switches	<ul style="list-style-type: none"> • Check operation. 	√	√	√	√	√	√

PERIODIC MAINTENANCE AND MINOR REPAIR

NO.	ITEM	CHECK OR MAINTENANCE JOB	ODOMETER READING (× 1000 km)					ANNUAL CHECK
			1	10	20	30	40	
26	Moving parts and cables	<ul style="list-style-type: none"> Lubricate. 		√	√	√	√	√
27	* Throttle grip housing and cable	<ul style="list-style-type: none"> Check operation and free play. Adjust the throttle cable free play if necessary. Lubricate the throttle grip housing and cable. 		√	√	√	√	√
28	* Lights, signals and switches	<ul style="list-style-type: none"> Check operation. Adjust headlight beam. 	√	√	√	√	√	√

EAU34490

NOTE:

- The air filters and V-belt filter need more frequent service if you are riding in unusually wet or dusty areas.
- Hydraulic brake service
 - Regularly check and, if necessary, correct the brake fluid level.
 - Every two years replace the internal components of the brake master cylinders and calipers, and change the brake fluid.
 - Replace the brake hoses every four years and if cracked or damaged.

PERIODIC MAINTENANCE AND MINOR REPAIR

EAU18712

Removing and installing cowlings and panels

The cowlings and panels shown need to be removed to perform some of the maintenance jobs described in this chapter. Refer to this section each time a cowling or panel needs to be removed and installed.

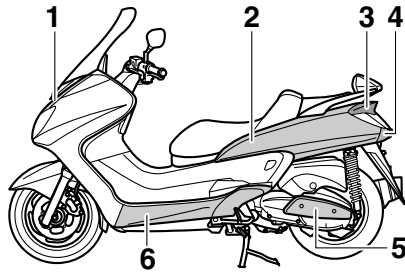

1. Panel A
2. Cowling C
3. Cowling A
4. Cowling B
5. Panel B
6. Cowling E

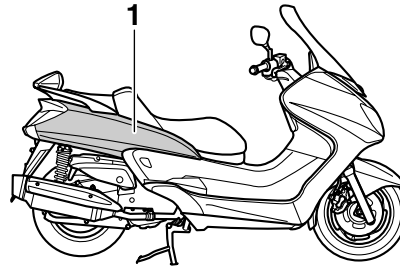

1. Cowling D

EAU34281

Cowling A

To remove the cowling

1. Open the rider seat. (See page 3-14.)
2. Remove the quick fasteners in the rear storage compartment, and then pull the cowling off as shown.

NOTE:

The quick fastener is removed by pushing the center pin in with a screwdriver, and then pulling the fastener out.

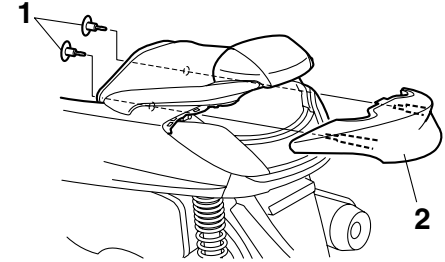

1. Quick fastener
2. Cowling A

To install the cowling

1. Place the cowling in the original position, and then install the quick fasteners.

NOTE:

To install the quick fastener, push the center pin out so that it will protrude from the fastener head, insert the fastener into the cowling, and then push the protruding pin in until it is flush with the fastener head.

2. Close the rider seat.

PERIODIC MAINTENANCE AND MINOR REPAIR

Cowling B

To remove the cowling

1. Remove the screws.

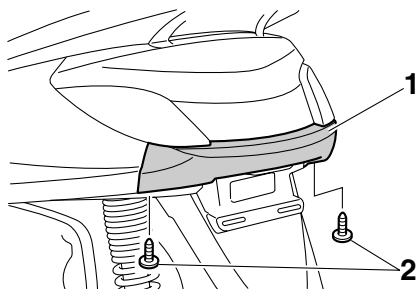

1. Cowling B
2. Screw

2. Remove the cowling as shown.

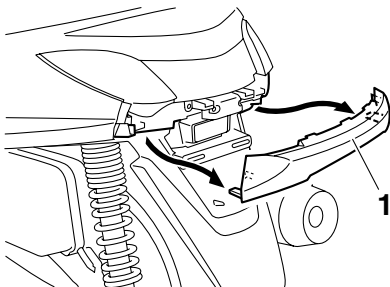

1. Cowling B

To install the cowling

Place the cowling in the original position, and then install the screws.

Cowlings C and D

To remove one of the cowlings

1. Remove cowlings A and B.
2. Remove the passenger seat. (See page 3-14.)
3. Remove the grab bar by removing the grab bar bolts and collars.

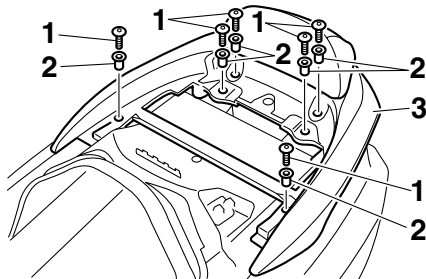

1. Grab bar bolt
2. Collar
3. Grab bar

4. Remove the screw access cover by pulling it off.

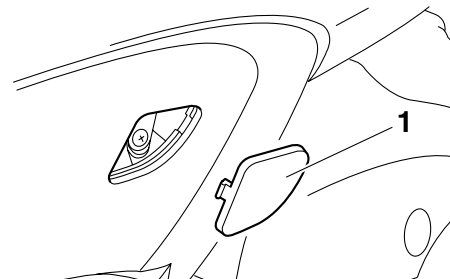

1. Screw access cover

5. Remove the screws, and then pull the cowling off.

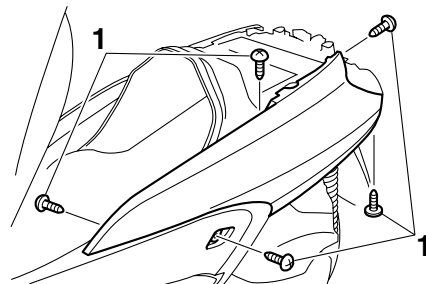

1. Screw

To install the cowling

1. Place the cowling in the original position, and then install the screws.

PERIODIC MAINTENANCE AND MINOR REPAIR

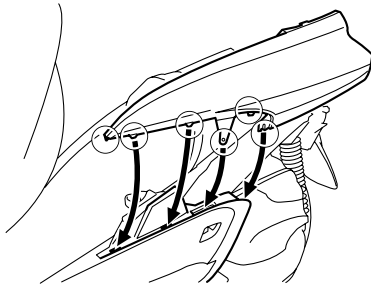

2. Install the screw access cover by placing it in its original position.
3. Install the grab bar by installing the collars and grab bar bolts.

Tightening torque:

Grab bar bolt:
23 Nm (2.3 m·kgf, 16.6 ft·lbf)

4. Install the passenger seat.
5. Install cowlings A and B.

Cowling E

To remove the cowling

1. Pull up the left floorboard mats as shown.

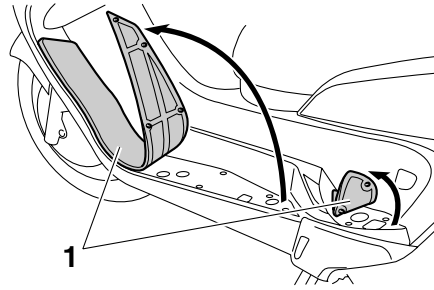

1. Left floorboard mat
2. Remove the cowling screws.

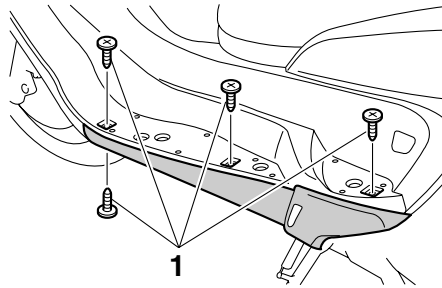

1. Screw
3. Pull the cowling down slightly, and then pull it outward as shown.

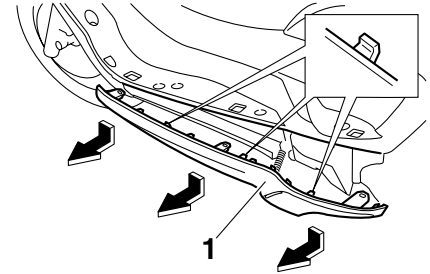

1. Cowling E

To install the cowling

1. Insert the tabs on the cowling into the slots as shown, and then install the screws.

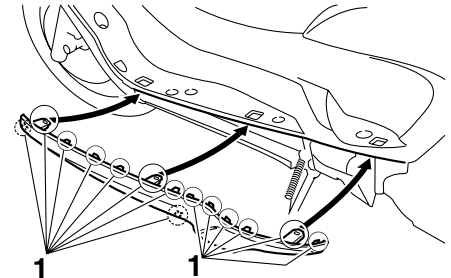

1. Tab

2. Place the left floorboard mats in the original position.

PERIODIC MAINTENANCE AND MINOR REPAIR

EAU34290

Panel A

To remove the panel

1. Remove the bolts.

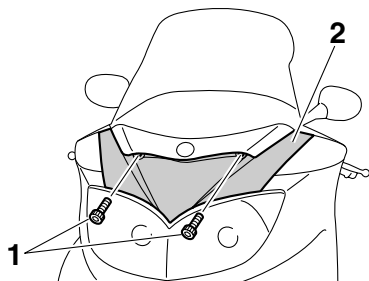

1. Bolt
2. Panel A

2. Pull the panel out as shown.

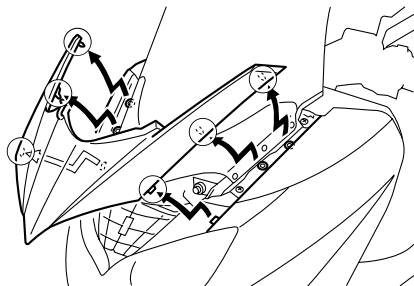

To install the panel

Place the panel in the original position, and then install the bolts.

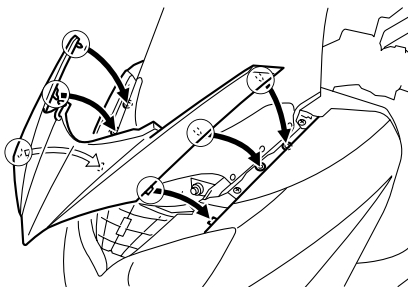

Panel B

To remove the panel

Remove the screws, and then pull the panel outward.

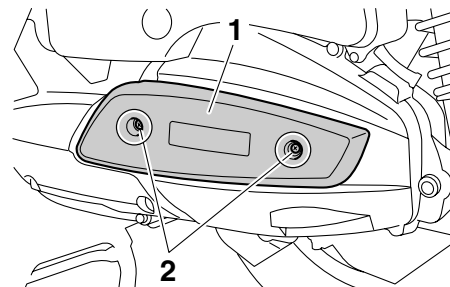

1. Panel B
2. Screw

To install the panel

Place the panel in the original position, and then install the screws.

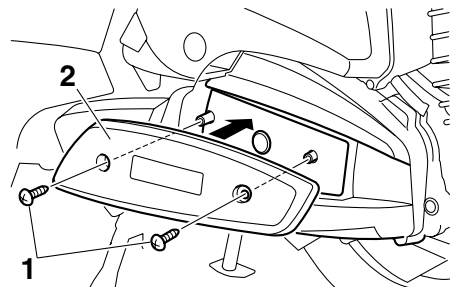

1. Screw
2. Panel B

PERIODIC MAINTENANCE AND MINOR REPAIR

EAU34172

Checking the spark plug

The spark plug is an important engine component, which is easy to check. Since heat and deposits will cause any spark plug to slowly erode, the spark plug should be removed and checked in accordance with the periodic maintenance and lubrication chart. In addition, the condition of the spark plug can reveal the condition of the engine.

To remove the spark plug

1. Open the rider seat. (See page 3-14.)
2. Pull up the storage compartment mat, and then remove the spark plug cover by removing the screws.

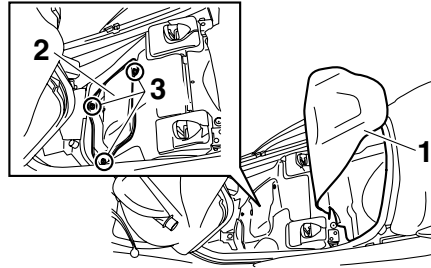

1. Storage compartment mat
2. Spark plug cover
3. Screw

3. Remove the spark plug cap.

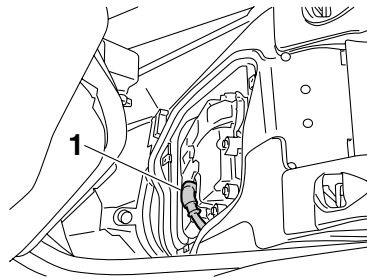

1. Spark plug cap

4. Remove the spark plug as shown, with the spark plug wrench included in the owner's tool kit.

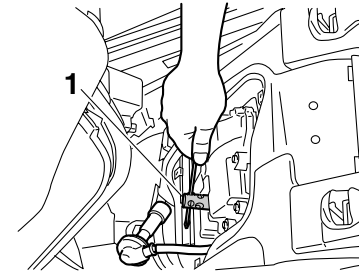

1. Spark plug wrench

To check the spark plug

1. Check that the porcelain insulator around the center electrode of the spark plug is a medium-to-light tan (the ideal color when the vehicle is ridden normally).

NOTE:

If the spark plug shows a distinctly different color, the engine could be operating improperly. Do not attempt to diagnose such problems yourself. Instead, have a Yamaha dealer check the vehicle.

2. Check the spark plug for electrode erosion and excessive carbon or other deposits, and replace it if

PERIODIC MAINTENANCE AND MINOR REPAIR

necessary.

Specified spark plug:
NGK/CR7E

To install the spark plug

1. Measure the spark plug gap with a wire thickness gauge and, if necessary, adjust the gap to specification.

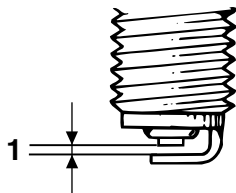

1. Spark plug gap

Spark plug gap:
0.7–0.8 mm (0.028–0.031 in)

2. Clean the surface of the spark plug gasket and its mating surface, and then wipe off any grime from the spark plug threads.

3. Install the spark plug with the spark plug wrench, and then tighten it to the specified torque.

Tightening torque:
Spark plug:
12.5 Nm (1.25 m·kgf, 9 ft·lbf)

NOTE:

If a torque wrench is not available when installing a spark plug, a good estimate of the correct torque is 1/4–1/2 turn past finger tight. However, the spark plug should be tightened to the specified torque as soon as possible.

4. Install the spark plug cap.

NOTE:

Make sure the spark plug wire is fastened in the clamp as shown.

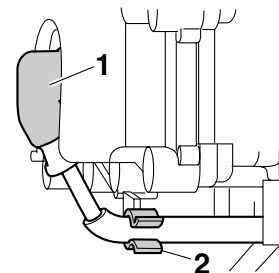

1. Spark plug cap
2. Spark plug wire clamp

5. Install the spark plug cover by installing the screws.
6. Place the storage compartment mat in the original position.
7. Close the rider seat.

PERIODIC MAINTENANCE AND MINOR REPAIR

EAU34181

Engine oil and oil filter element

The engine oil level should be checked before each ride. In addition, the oil must be changed and the oil filter element replaced at the intervals specified in the periodic maintenance and lubrication chart and when the oil change indicator comes on.

To check the engine oil level

1. Place the vehicle on the center-stand.

NOTE:

Make sure that the vehicle is positioned straight up when checking the oil level. A slight tilt to the side can result in a false reading.

2. Start the engine, warm it up for several minutes, and then turn it off.
3. Wait a few minutes until the oil settles, remove the oil filler cap, wipe the dipstick clean, insert it back into the oil filler hole (without screwing it in), and then remove it

again to check the oil level.

NOTE:

The engine oil should be between the minimum and maximum level marks.

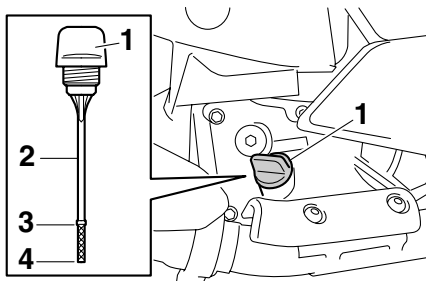

1. Engine oil filler cap
 2. Dipstick
 3. Maximum level mark
 4. Minimum level mark
4. If the engine oil is below the minimum level mark, add sufficient oil of the recommended type to raise it to the correct level.
 5. Insert the dipstick into the oil filler hole, and then tighten the oil filler cap.

To change the engine oil (with or without oil filter element replacement)

1. Start the engine, warm it up for several minutes, and then turn it off.
2. Place an oil pan under the engine to collect the used oil.
3. Remove the engine oil filler cap and the engine oil drain bolt to drain the oil from the crankcase.

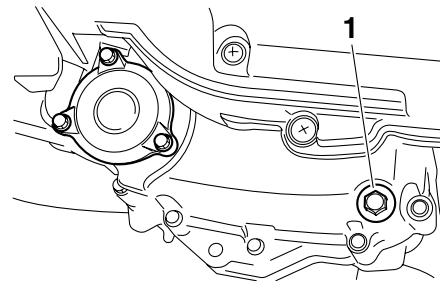

1. Engine oil drain bolt
4. Check the washer for damage and replace it if necessary.

PERIODIC MAINTENANCE AND MINOR REPAIR

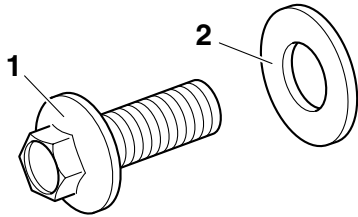

1. Engine oil drain bolt
2. Washer

NOTE: _____
Skip steps 5–7 if the oil filter element is not being replaced.

5. Remove the oil filter element cover by removing the bolts.

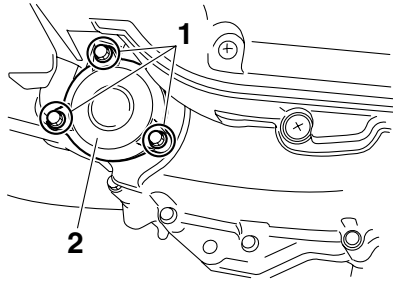

1. Bolt
2. Oil filter element cover

6. Remove and replace the oil filter element and O-rings.

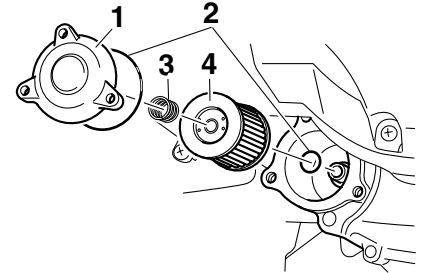

1. Oil filter element cover
2. O-ring
3. Compression spring
4. Oil filter element

CAUTION: _____

When removing the oil filter element cover, the compression spring will fall out. Take care not to lose the compression spring.

7. Install the compression spring and oil filter element cover by installing the bolts, then tightening them to the specified torque.

ECA12910

PERIODIC MAINTENANCE AND MINOR REPAIR

Tightening torque:

Oil filter element cover bolt:
10 Nm (1.0 m·kgf, 7.2 ft·lbf)

NOTE:

Make sure that the O-rings are properly seated.

8. Install the washer and the engine oil drain bolt, and then tighten the drain bolt to the specified torque.

Tightening torque:

Engine oil drain bolt:
20 Nm (2.0 m·kgf, 14.5 ft·lbf)

NOTE:

Make sure that the washer is properly seated.

9. Add the specified amount of the recommended engine oil, and then install and tighten the oil filler cap.

Recommended engine oil:

See page 8-1.

Oil quantity:

Without oil filter element replacement:

1.50 L (1.59 US qt) (1.32 Imp.qt)

With oil filter element replacement:
1.70 L (1.80 US qt) (1.50 Imp.qt)

ECA11670

CAUTION:

- Do not use oils with a diesel specification of “CD” or oils of a higher quality than specified. In addition, do not use oils labeled “ENERGY CONSERVING II” or higher.
- Be sure no foreign material enters the crankcase.

10. Start the engine, and then let it idle for several minutes while checking it for oil leakage. If oil is leaking, immediately turn the engine off and check for the cause.
11. Reset the oil change indicator according to the following procedure.

To reset the oil change indicator

1. Turn the key to “ON”.

2. Hold the “OIL CHANGE” button pushed for two to eight seconds.

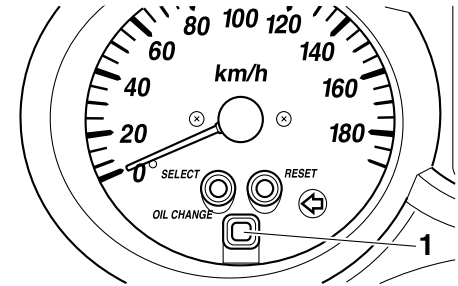

1. “OIL CHANGE” button

3. Release the “OIL CHANGE” button, and the oil change indicator will go off.

NOTE:

If the engine oil is changed before the oil change indicator comes on (i.e. before the periodic oil change interval has been reached), the indicator must be reset after the oil change for the next periodic oil change to be indicated at the correct time. To reset the oil change indicator before the periodic oil change interval has been reached, follow the above procedure, but note that the indicator will come on for 1.4 seconds after

PERIODIC MAINTENANCE AND MINOR REPAIR

releasing the “OIL CHANGE” button, otherwise repeat the procedure.

EAU20061

Final transmission oil

The final transmission case must be checked for oil leakage before each ride. If any leakage is found, have a Yamaha dealer check and repair the scooter. In addition, the final transmission oil must be changed as follows at the intervals specified in the periodic maintenance and lubrication chart.

1. Start the engine, warm up the final transmission oil by riding the scooter for several minutes, and then stop the engine.
2. Place the scooter on the center-stand.
3. Place an oil pan under the final transmission case to collect the used oil.
4. Remove the oil filler cap and drain bolt to drain the oil from the final transmission case.

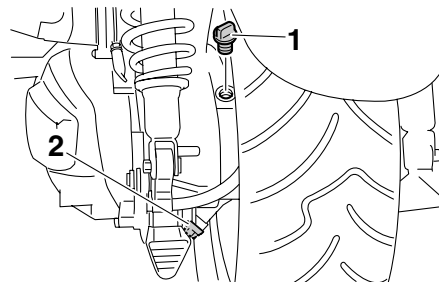

1. Final transmission oil filler cap
2. Final transmission oil drain bolt

5. Install the final transmission oil drain bolt, and then tighten it to the specified torque.

Tightening torque:

Final transmission oil drain bolt:
20 Nm (2.0 m·kgf, 14.5 ft·lbf)

6. Add the specified amount of the recommended final transmission oil, and then install and tighten the oil filler cap.

Recommended final transmission oil:

See page 8-1.

Oil quantity:

0.25 L (0.26 US qt) (0.22 Imp.qt)

PERIODIC MAINTENANCE AND MINOR REPAIR

EWA11310

WARNING

- **Make sure that no foreign material enters the final transmission case.**
- **Make sure that no oil gets on the tire or wheel.**

7. Check the final transmission case for oil leakage. If oil is leaking, check for the cause.

EAU20070

Coolant

The coolant level should be checked before each ride. In addition, the coolant must be changed at the intervals specified in the periodic maintenance and lubrication chart.

EAU34192

To check the coolant level

1. Place the vehicle on a level surface and hold it in an upright position.

NOTE:

- The coolant level must be checked on a cold engine since the level varies with engine temperature.
- Make sure that the vehicle is positioned straight up when checking the coolant level. A slight tilt to the side can result in a false reading.

2. Pull up the right floorboard mat as shown.

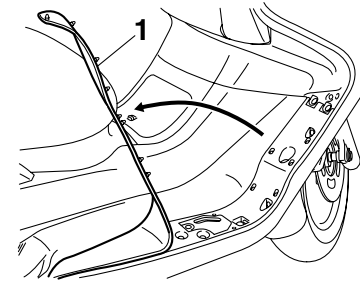

1. Right floorboard mat

3. Remove the coolant reservoir cover by removing the screw.

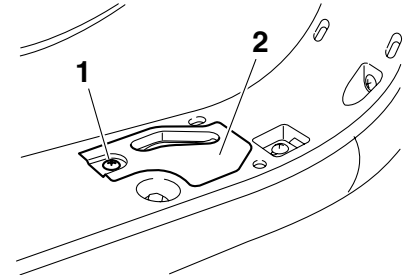

1. Screw
2. Coolant reservoir cover

4. Check the coolant level in the coolant reservoir.

PERIODIC MAINTENANCE AND MINOR REPAIR

NOTE: _____

The coolant should be between the minimum and maximum level marks.

5. If the coolant is at or below the minimum level mark, open the coolant reservoir cap, add coolant to the maximum level mark, and then close the coolant reservoir cap.

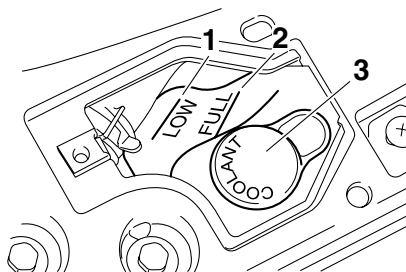

1. Minimum level mark
2. Maximum level mark
3. Coolant reservoir cap

Coolant reservoir capacity (up to the maximum level mark):

0.32 L (0.34 US qt) (0.28 Imp.qt)

ECA10471

CAUTION: _____

- If coolant is not available, use distilled water or soft tap water instead. Do not use hard water or salt water since it is harmful to the engine.
- If water has been used instead of coolant, replace it with coolant as soon as possible, otherwise the cooling system will not be protected against frost and

corrosion.

- If water has been added to the coolant, have a Yamaha dealer check the antifreeze content of the coolant as soon as possible, otherwise the effectiveness of the coolant will be reduced.

EWA10380

⚠ WARNING _____

Never attempt to remove the radiator cap when the engine is hot.

6. Install the coolant reservoir cover by installing the screw.
7. Place the right floorboard mat in the original position.

NOTE: _____

- The radiator fan is automatically switched on or off according to the coolant temperature in the radiator.
- If the engine overheats, see page 6-39 for further instructions.

PERIODIC MAINTENANCE AND MINOR REPAIR

EAU34204

Air filter elements and check hoses and V-belt case air filter element

The air filter elements and the V-belt case air filter element should be serviced at the intervals specified in the periodic maintenance and lubrication chart. Service all air filter elements more frequently if you are riding in unusually wet or dusty areas.

Replacing the air filter elements

1. Place the scooter on the center-stand.

NOTE: _____
Continue as follows for each air filter element.

2. Remove the air filter case cover by removing the rubber cap and screws.

Left

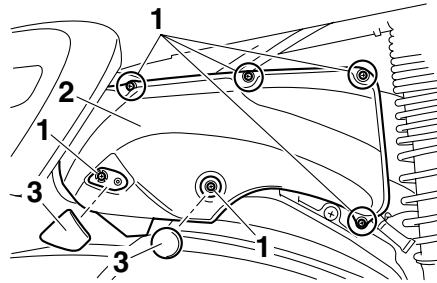

1. Screw
2. Air filter case cover
3. Rubber cap

Right

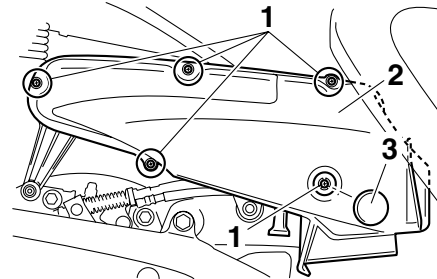

1. Screw
2. Air filter case cover
3. Rubber cap

3. Pull the air filter element out.

Left

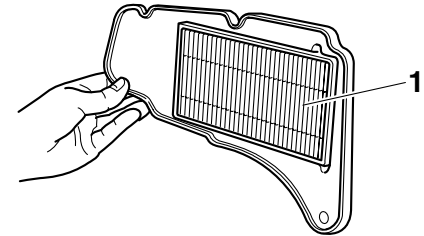

1. Air filter element

Right

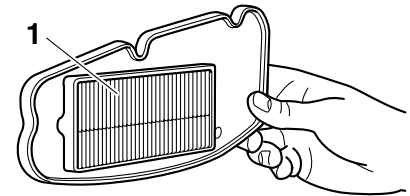

1. Air filter element

4. Insert a new air filter element into the air filter case.
5. Install the air filter case cover by installing the screws.

PERIODIC MAINTENANCE AND MINOR REPAIR

6. Install the rubber cap.

ECA12922

CAUTION:

- Make sure that each filter element is properly seated in its case.
- Always replace both air filter elements at the same time, otherwise poor engine performance or damage to the engine may result.
- The engine should never be operated without the filter elements installed, otherwise the piston(s) and/or cylinder(s) may become excessively worn.

To clean the air filter check hoses

1. Check the hose at the bottom of both air filter cases for accumulated dirt or water.

Left

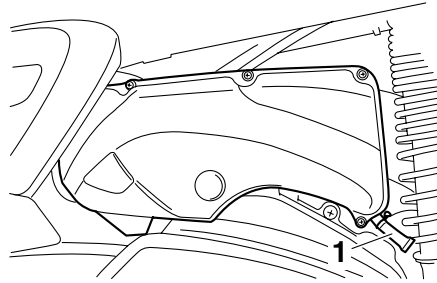

1. Air filter check hose

Right

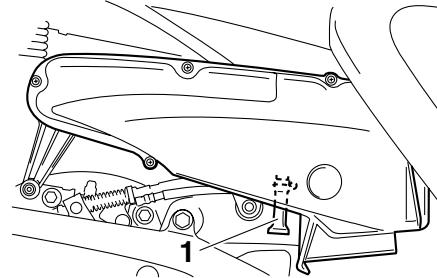

1. Air filter check hose

2. If dirt or water is visible, remove the hose, clean it, and then install it.

Cleaning the V-belt case air filter element

1. Remove cowling E. (See page 6-6.)
2. Remove panel B. (See page 6-6.)
3. Remove the left air filter case cover.
4. Remove the V-belt air filter case cover by removing the screws.

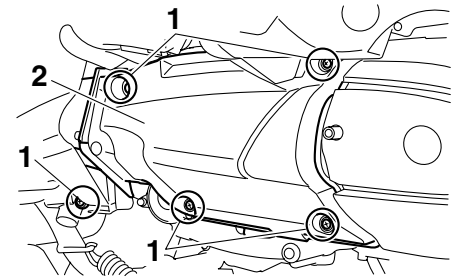

1. Screw
2. V-belt air filter case cover

5. Remove the V-belt case air filter element by removing the screws.

PERIODIC MAINTENANCE AND MINOR REPAIR

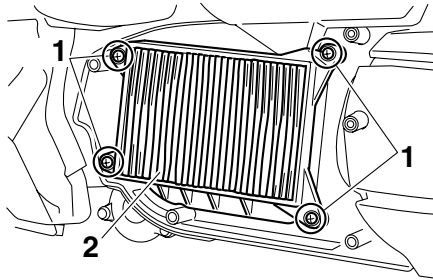

1. Screw
2. V-belt case air filter element

6. Lightly tap the V-belt case air filter element to remove most of the dust and dirt, and then blow out the dirt with compressed air as shown.

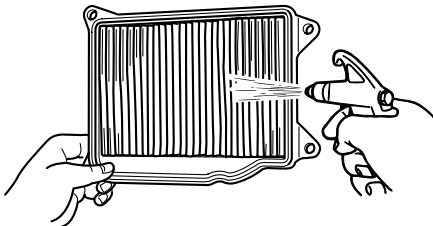

7. Check the V-belt case air filter element for damage and replace it if

necessary.

8. Install the V-belt case air filter element by installing the screws.
9. Install the V-belt air filter case cover by installing the screws.

ECA12940

CAUTION:

Make sure that the V-belt filter element is properly seated in its case.

10. Install the left air filter case cover.
11. Install the panel.
12. Install the cowling.

Checking the throttle cable free play

EAU21381

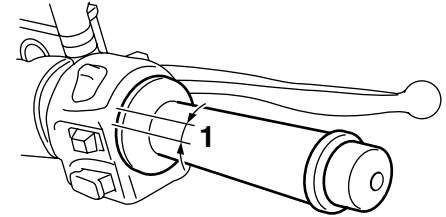

1. Throttle cable free play

The throttle cable free play should measure 3.0–5.0 mm (0.12–0.20 in) at the throttle grip. Periodically check the throttle cable free play and, if necessary, have a Yamaha dealer adjust it.

PERIODIC MAINTENANCE AND MINOR REPAIR

EAU21401

Valve clearance

The valve clearance changes with use, resulting in improper air-fuel mixture and/or engine noise. To prevent this from occurring, the valve clearance must be adjusted by a Yamaha dealer at the intervals specified in the periodic maintenance and lubrication chart.

EAU21871

Tires

To maximize the performance, durability, and safe operation of your vehicle, note the following points regarding the specified tires.

Tire air pressure

The tire air pressure should be checked and, if necessary, adjusted before each ride.

EWA10500

WARNING

- **The tire air pressure must be checked and adjusted on cold tires (i.e., when the temperature of the tires equals the ambient temperature).**
- **The tire air pressure must be adjusted in accordance with the riding speed and with the total weight of rider, passenger, cargo, and accessories approved for this model.**

Tire air pressure (measured on cold tires):

0–90 kg (0–198 lb):

Front:

200 kPa (29 psi) (2.00 kgf/cm²)

Rear:

250 kPa (36 psi) (2.50 kgf/cm²)

YP400 90–189 kg (198–417 lb)

YP400A 90–185 kg (198–408 lb):

Front:

200 kPa (29 psi) (2.00 kgf/cm²)

Rear:

250 kPa (36 psi) (2.50 kgf/cm²)

Maximum load*:

YP400 189 kg (417 lb)

YP400A 185 kg (408 lb)

* Total weight of rider, passenger, cargo and accessories

EWA14660

WARNING

Because loading has an enormous impact on the handling, braking, performance and safety characteristics of your vehicle, you should keep the following precautions in mind.

- **NEVER OVERLOAD THE VEHICLE!** Operation of an overloaded vehicle may result in tire damage, loss of control, or severe injury. Make sure that the

PERIODIC MAINTENANCE AND MINOR REPAIR

total weight of rider, passenger, cargo, and accessories does not exceed the specified maximum load for the vehicle.

- Do not carry along loosely packed items, which can shift during a ride.
- Securely pack the heaviest items close to the center of the vehicle and distribute the weight evenly on both sides.
- Adjust the suspension and tire air pressure with regard to the load.
- Check the tire condition and air pressure before each ride.

Tire inspection

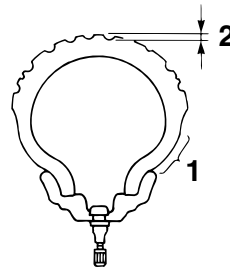

1. Tire sidewall
2. Tire tread depth

The tires must be checked before each ride. If the center tread depth reaches the specified limit, if the tire has a nail or glass fragments in it, or if the sidewall is cracked, have a Yamaha dealer replace the tire immediately.

Minimum tire tread depth (front and rear):
1.6 mm (0.06 in)

NOTE:

The tire tread depth limits may differ from country to country. Always comply with the local regulations.

Tire information

This model is equipped with tubeless tires.

Front tire:

Size:
120/80-14M/C 58S
Manufacturer/model:
IRC/MB67
DUNLOP/D305FL

Rear tire:

Size:
150/70-13M/C 64S
Manufacturer/model:
IRC/MB67
DUNLOP/D305L

EWA10470

⚠ WARNING

- Have a Yamaha dealer replace excessively worn tires. Besides being illegal, operating the vehicle with excessively worn tires decreases riding stability and can lead to loss of control.
- The replacement of all wheel and brake related parts, including the tires, should be left to a Yamaha dealer, who has the necessary professional knowl-

PERIODIC MAINTENANCE AND MINOR REPAIR

edge and experience.

EAU21992

Cast wheels

To maximize the performance, durability, and safe operation of your vehicle, note the following points regarding the specified wheels.

- The wheel rims should be checked for cracks, bends, warpage or damage before each ride. If any damage is found, have a Yamaha dealer replace the wheel. Do not attempt even the smallest repair to the wheel. A deformed or cracked wheel must be replaced.
- The wheel should be balanced whenever either the tire or wheel has been changed or replaced. An unbalanced wheel can result in poor performance, adverse handling characteristics, and a shortened tire life.
- Ride at moderate speeds after changing a tire since the tire surface must first be “broken in” for it to develop its optimal characteristics.
- After repairing or replacing the rear tire, tighten the valve stem nut and locknut to the specified torques.

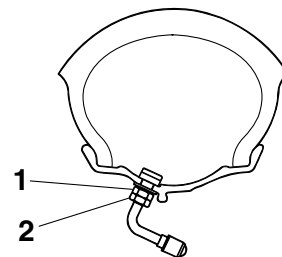

1. Valve stem nut
2. Valve stem locknut

Tightening torques:

Valve stem nut:
2.0 Nm (0.2 m·kgf, 1.4 ft·lbf)
Valve stem locknut:
3.0 Nm (0.3 m·kgf, 2.2 ft·lbf)

PERIODIC MAINTENANCE AND MINOR REPAIR

Front and rear brake lever free play

EAU33453

Front

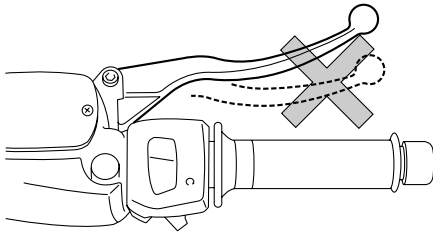

Rear

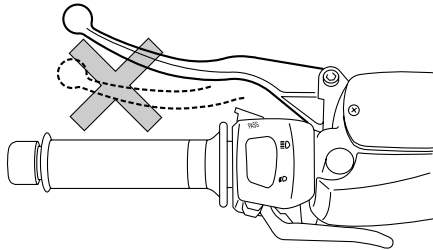

There should be no free play at the brake lever ends. If there is free play, have a Yamaha dealer inspect the

brake system.



A soft or spongy feeling in the brake lever can indicate the presence of air in the hydraulic system. If there is air in the hydraulic system, have a Yamaha dealer bleed the system before operating the vehicle. Air in the hydraulic system will diminish the braking performance, which may result in loss of control and an accident.

EWA14211

Adjusting the rear brake lock lever cable

EAU33473

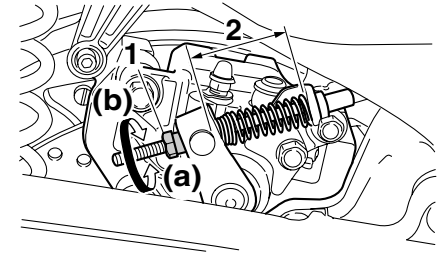

1. Adjusting nut
2. Rear brake lock lever cable length

Rear brake lock lever cable adjustment may be required if the rear brake lock lever does not hold properly. When the rear brake lock lever is not in use, the rear brake lock lever cable length should measure 45 mm to 47 mm (1.77 in to 1.85 in) at the rear brake caliper. Periodically check the rear brake lock lever cable length and, if necessary, adjust it as follows.

To increase the rear brake lock lever cable length, turn the adjusting nut at the rear brake caliper in direction (a).

PERIODIC MAINTENANCE AND MINOR REPAIR

To decrease the rear brake lock lever cable length, turn the adjusting nut in direction (b).

EWA10650



If proper adjustment cannot be obtained as described, have a Yamaha dealer make this adjustment.

Checking the front and rear brake pads

EAU22390

The front and rear brake pads must be checked for wear at the intervals specified in the periodic maintenance and lubrication chart.

EAU22430

Front brake pads

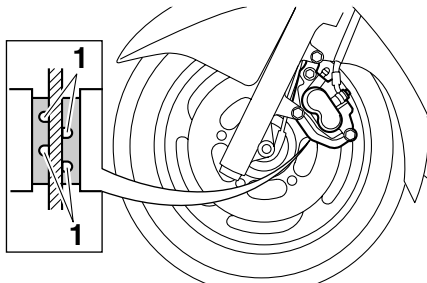

1. Wear indicator groove

Each front brake pad is provided with wear indicator grooves, which allow you to check the brake pad wear without having to disassemble the brake. To check the brake pad wear, check the wear indicator grooves. If a brake pad has worn to the point that the wear

indicator grooves have almost disappeared, have a Yamaha dealer replace the brake pads as a set.

EAU34210

Rear brake pads

Have a Yamaha dealer check each rear brake pad for damage and measure the lining thickness and if necessary, replace them as a set.

PERIODIC MAINTENANCE AND MINOR REPAIR

EAU22580

Checking the brake fluid level

Front brake

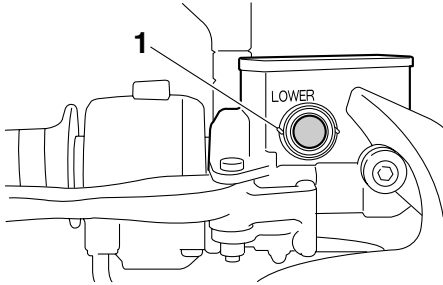

1. Minimum level mark

Rear brake

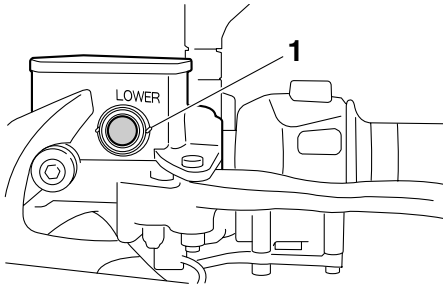

1. Minimum level mark

Insufficient brake fluid may allow air to

enter the brake system, possibly causing it to become ineffective.

Before riding, check that the brake fluid is above the minimum level mark and replenish if necessary. A low brake fluid level may indicate worn brake pads and/or brake system leakage. If the brake fluid level is low, be sure to check the brake pads for wear and the brake system for leakage.

Observe these precautions:

- When checking the fluid level, make sure that the top of the brake fluid reservoir is level.
- Use only the recommended quality brake fluid, otherwise the rubber seals may deteriorate, causing leakage and poor braking performance.

Recommended brake fluid:

DOT 4

- Refill with the same type of brake fluid. Mixing fluids may result in a harmful chemical reaction and lead to poor braking performance.
- Be careful that water does not enter the brake fluid reservoir when

refilling. Water will significantly lower the boiling point of the fluid and may result in vapor lock.

- Brake fluid may deteriorate painted surfaces or plastic parts. Always clean up spilled fluid immediately.
- As the brake pads wear, it is normal for the brake fluid level to gradually go down. However, if the brake fluid level goes down suddenly, have a Yamaha dealer check the cause.

PERIODIC MAINTENANCE AND MINOR REPAIR

EAU22730

Changing the brake fluid

Have a Yamaha dealer change the brake fluid at the intervals specified in the NOTE after the periodic maintenance and lubrication chart. In addition, have the oil seals of the master cylinders and calipers as well as the brake hoses replaced at the intervals listed below or whenever they are damaged or leaking.

- Oil seals: Replace every two years.
- Brake hoses: Replace every four years.

EAU23100

Checking and lubricating the cables

The operation of all control cables and the condition of the cables should be checked before each ride, and the cables and cable ends should be lubricated if necessary. If a cable is damaged or does not move smoothly, have a Yamaha dealer check or replace it.

Recommended lubricant:
Engine oil

EWA10720



Damage to the outer sheath may interfere with proper cable operation and will cause the inner cable to rust. Replace a damaged cable as soon as possible to prevent unsafe conditions.

EAU23111

Checking and lubricating the throttle grip and cable

The operation of the throttle grip should be checked before each ride. In addition, the cable should be lubricated at the intervals specified in the periodic maintenance chart.

PERIODIC MAINTENANCE AND MINOR REPAIR

EAU23170

Lubricating the front and rear brake levers

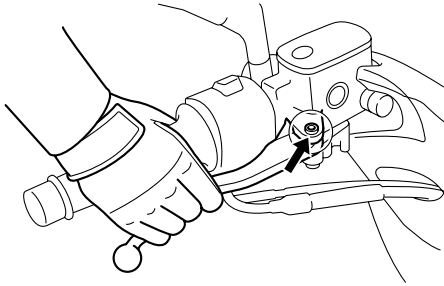

The pivoting points of the front and rear brake levers must be lubricated at the intervals specified in the periodic maintenance and lubrication chart.

Recommended lubricant:

Lithium-soap-based grease (all-purpose grease)

EAU23211

Checking and lubricating the centerstand and sidestand

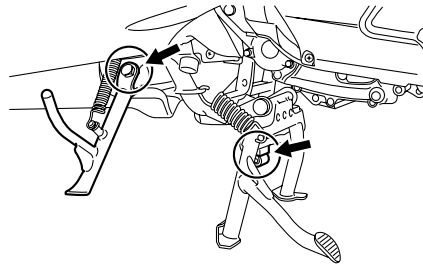
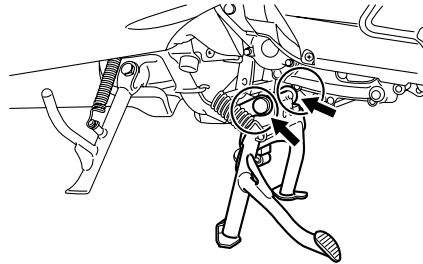

The operation of the centerstand and sidestand should be checked before each ride, and the pivots and metal-to-metal contact surfaces should be lubricated if necessary.

EWA10740

⚠ WARNING

If the centerstand or sidestand does not move up and down smoothly, have a Yamaha dealer check or repair it.

Recommended lubricant:

Lithium-soap-based grease (all-purpose grease)

PERIODIC MAINTENANCE AND MINOR REPAIR

EAU23271

Checking the front fork

The condition and operation of the front fork must be checked as follows at the intervals specified in the periodic maintenance and lubrication chart.

To check the condition

EWA10750



WARNING

Securely support the vehicle so that there is no danger of it falling over.

Check the inner tubes for scratches, damage and excessive oil leakage.

To check the operation

1. Place the vehicle on a level surface and hold it in an upright position.
2. While applying the front brake, push down hard on the handlebars several times to check if the front fork compresses and rebounds smoothly.

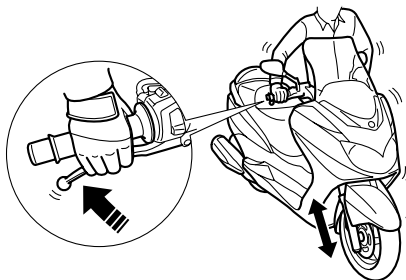

ECA10590

CAUTION:

If any damage is found or the front fork does not operate smoothly, have a Yamaha dealer check or repair it.

EAU23280

Checking the steering

Worn or loose steering bearings may cause danger. Therefore, the operation of the steering must be checked as follows at the intervals specified in the periodic maintenance and lubrication chart.

1. Place a stand under the engine to raise the front wheel off the ground.

EWA10750



WARNING

Securely support the vehicle so that there is no danger of it falling over.

2. Hold the lower ends of the front fork legs and try to move them forward and backward. If any free play can be felt, have a Yamaha dealer check or repair the steering.

PERIODIC MAINTENANCE AND MINOR REPAIR

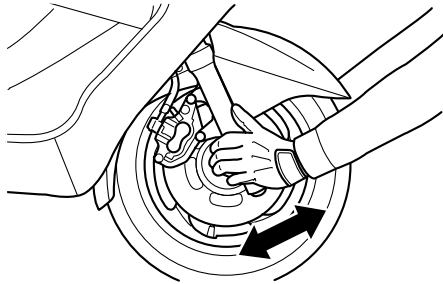

EAU23290

Checking the wheel bearings

The front and rear wheel bearings must be checked at the intervals specified in the periodic maintenance and lubrication chart. If there is play in the wheel hub or if the wheel does not turn smoothly, have a Yamaha dealer check the wheel bearings.

Battery

EAU34221

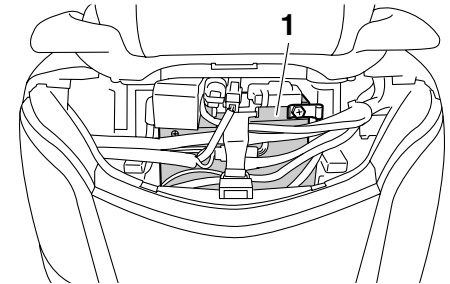

1. Battery

The battery is located behind cowling A. (See page 6-6.)

This model is equipped with a sealed-type (MF) battery, which does not require any maintenance. There is no need to check the electrolyte or to add distilled water.

EWA10760

WARNING

- **Electrolyte is poisonous and dangerous since it contains sulfuric acid, which causes severe burns. Avoid any contact with skin, eyes or clothing and always shield your eyes when**

PERIODIC MAINTENANCE AND MINOR REPAIR

working near batteries. In case of contact, administer the following FIRST AID.

- **EXTERNAL:** Flush with plenty of water.
 - **INTERNAL:** Drink large quantities of water or milk and immediately call a physician.
 - **EYES:** Flush with water for 15 minutes and seek prompt medical attention.
 - **Batteries produce explosive hydrogen gas. Therefore, keep sparks, flames, cigarettes, etc., away from the battery and provide sufficient ventilation when charging it in an enclosed space.**
 - **KEEP THIS AND ALL BATTERIES OUT OF THE REACH OF CHILDREN.**
-

To charge the battery

Have a Yamaha dealer charge the battery as soon as possible if it seems to have discharged. Keep in mind that the battery tends to discharge more quickly if the vehicle is equipped with optional

electrical accessories.

To store the battery

1. If the vehicle will not be used for more than one month, remove the battery, fully charge it, and then place it in a cool, dry place.
2. If the battery will be stored for more than two months, check it at least once a month and fully charge it if necessary.
3. Fully charge the battery before installation.
4. After installation, make sure that the battery leads are properly connected to the battery terminals.

ECA10630

CAUTION:

- **Always keep the battery charged. Storing a discharged battery can cause permanent battery damage.**
- **To charge a sealed-type (MF) battery, a special (constant-voltage) battery charger is required. Using a conventional battery charger will damage the battery. If you do not have access to a sealed-type (MF) battery charg-**

er, have a Yamaha dealer charge your battery.

PERIODIC MAINTENANCE AND MINOR REPAIR

EAU42820

Replacing the fuses

The main fuse and the fuse box, which contains the fuses for the individual circuits, are located behind cowling A. (See page 6-6.)

If a fuse is blown, replace it as follows.

1. Turn the key to "OFF" and turn off the electrical circuit in question.
2. Remove the blown fuse, and then install a new fuse of the specified amperage.

NOTE: _____

If the main fuse is blown, remove the grab bar to access the main fuse. After replacing the main fuse, install the grab bar. (See page 6-6.)

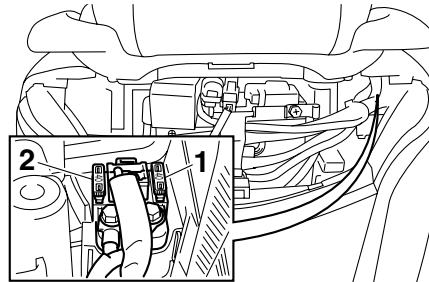

1. Spare main fuse
2. Main fuse

(for non-ABS models)

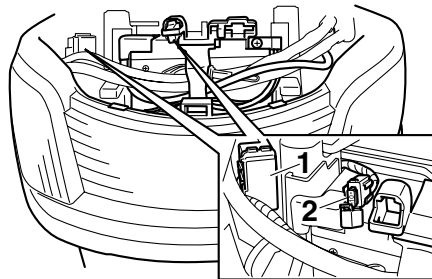

1. Fuse box
2. Hazard fuse

(for ABS models)

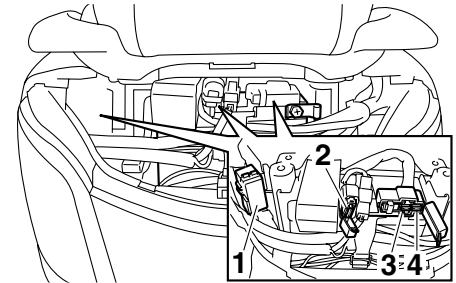

1. Fuse box
2. ABS motor fuse
3. ABS control unit fuse
4. Hazard fuse

PERIODIC MAINTENANCE AND MINOR REPAIR

(for non-ABS models)

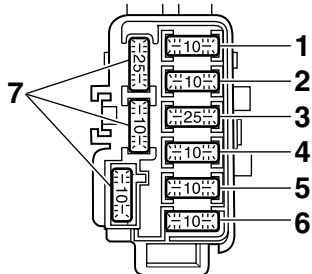

1. Ignition fuse
2. Signaling system fuse
3. Headlight fuse
4. Radiator fan fuse
5. Backup fuse (for odometer and clock)
6. Fuel injection system fuse
7. Spare fuse

(for ABS models)

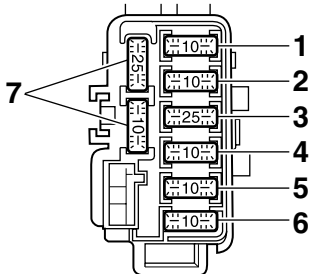

1. Ignition fuse
2. Signaling system fuse
3. Headlight fuse
4. Radiator fan fuse
5. Backup fuse (for odometer and clock)
6. Fuel injection system fuse
7. Spare fuse

Specified fuses:

- Main fuse:
40.0 A
- Ignition fuse:
10.0 A
- Signaling system fuse:
10.0 A
- Headlight fuse:
25.0 A
- Hazard fuse:
10.0 A
- Radiator fan fuse:
10.0 A
- Fuel injection system fuse:
10.0 A
- ABS control unit fuse:
YP400A 10.0 A
- ABS motor fuse:
YP400A 30.0 A
- Backup fuse:
10.0 A

ECA10640

CAUTION:

Do not use a fuse of a higher amperage rating than recommended to avoid causing extensive damage to the electrical system and possibly a fire.

3. Turn the key to "ON" and turn on the electrical circuit in question to

PERIODIC MAINTENANCE AND MINOR REPAIR

check if the device operates.

4. If the fuse immediately blows again, have a Yamaha dealer check the electrical system.

EAU34240

Replacing a headlight bulb

This model is equipped with quartz bulb headlights. If a headlight bulb burns out, have a Yamaha dealer replace it and, if necessary, adjust the headlight beam.

EAU24180

Tail/brake light

This model is equipped with an LED type of tail/brake light. If the tail/brake light does not come on, have a Yamaha dealer check it.

PERIODIC MAINTENANCE AND MINOR REPAIR

EAU36122

Replacing a front turn signal light bulb

1. Place the scooter on the center-stand.
2. Remove panel A. (See page 6-6.)
3. Remove the windshield by removing the screws.

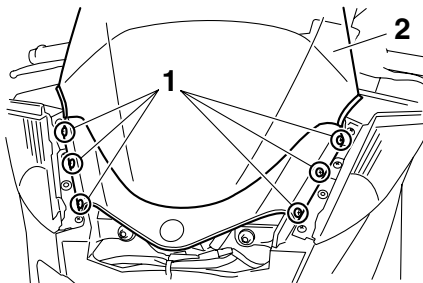

1. Screw
2. Windshield

4. Remove the front turn signal light unit by removing the screws.

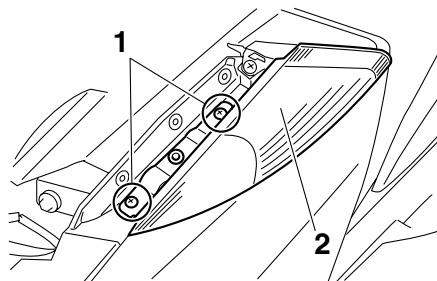

1. Screw
2. Front turn signal light unit

5. Remove the socket (together with the bulb) by turning it counter-clockwise.

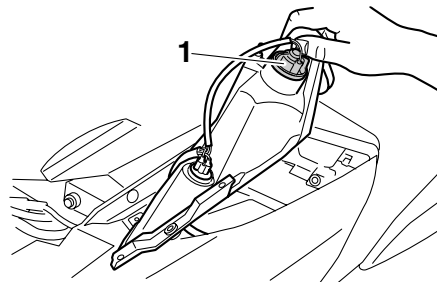

1. Turn signal light bulb socket

6. Remove the defective bulb by pushing it in and turning it counter-

clockwise.

7. Insert a new bulb into the socket, push it in, and then turn it clockwise until it stops.
8. Install the socket (together with the bulb) by turning it clockwise.
9. Place the turn signal light unit in the original position, and then install the screws.

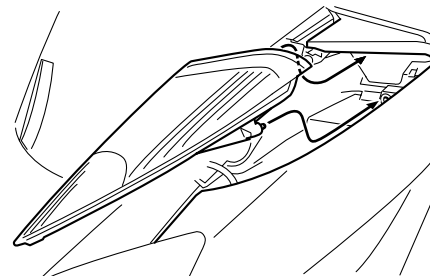

10. Install the windshield by installing the screws.
11. Install panel A.

PERIODIC MAINTENANCE AND MINOR REPAIR

EAU34260

Replacing a rear turn signal light bulb

1. Place the scooter on the center-stand.
2. Remove cowling C for replacing the left turn signal light bulb or cowling D for replacing the right turn signal light bulb. (See page 6-6.)
3. Remove the socket (together with the turn signal light bulb) by turning it counterclockwise.

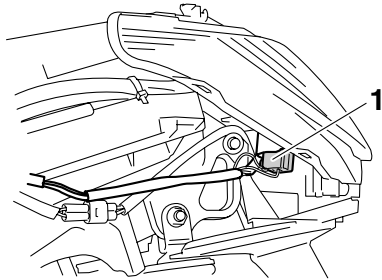

1. Turn signal light bulb socket
4. Remove the defective bulb by pushing it in and turning it counterclockwise.
5. Insert a new bulb into the socket,

push it in, and then turn it clockwise until it stops.

6. Install the socket (together with the bulb) by turning it clockwise.
7. Install the cowling removed.

EAU34270

Replacing the license plate light bulb

1. Remove cowling B. (See page 6-6.)
2. Remove the license plate light cover and license plate light lens by removing the screws.

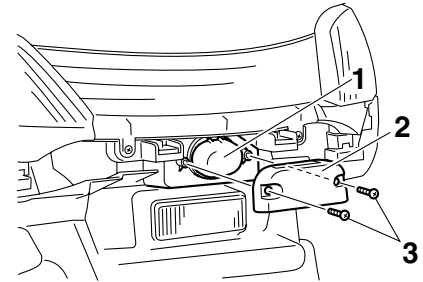

1. License plate light lens
2. License plate light cover
3. Screw

3. Remove the defective bulb by pushing it in and turning it counterclockwise.

PERIODIC MAINTENANCE AND MINOR REPAIR

EAU42800

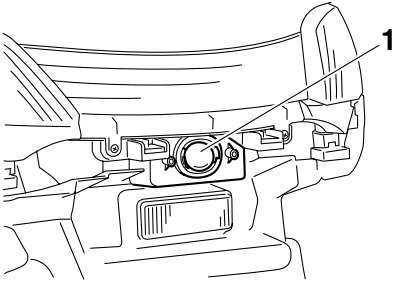

1. Bulb

4. Insert a new bulb into the socket, push it in, and then turn it clockwise until it stops.
5. Install the license plate light lens and license plate light cover by installing the screws.
6. Install the cowling.

Replacing an auxiliary light bulb

1. Place the scooter on the center-stand.
2. Remove panel A. (See page 6-6.)
3. Remove the windshield by removing the screws.

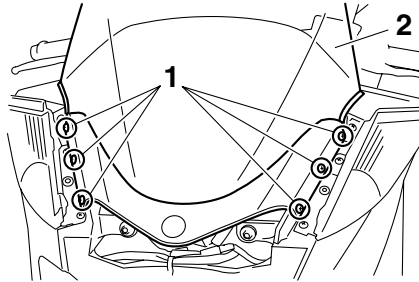

1. Screw
2. Windshield

4. Remove the front turn signal light unit by removing the screws.

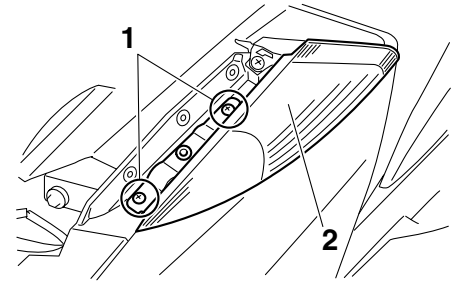

1. Screw
2. Front turn signal light unit

5. Remove the auxiliary light bulb socket (together with the bulb) by turning it counterclockwise.

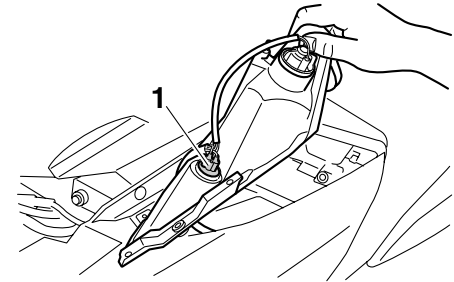

1. Auxiliary light bulb socket

6. Remove the defective bulb by pulling it out.

7. Insert a new bulb into the socket.
8. Install the socket (together with the bulb) by turning it clockwise.
9. Place the turn signal light unit in the original position, and then install the screws.

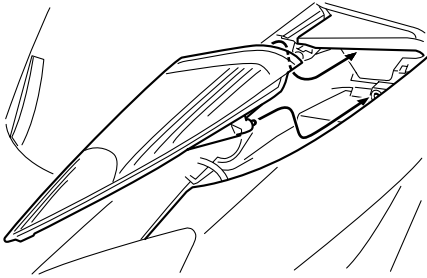

10. Install the windshield by installing the screws.
11. Install panel A.

EAU25880

Troubleshooting

Although Yamaha scooters receive a thorough inspection before shipment from the factory, trouble may occur during operation. Any problem in the fuel, compression, or ignition systems, for example, can cause poor starting and loss of power.

The following troubleshooting charts represent quick and easy procedures for checking these vital systems yourself. However, should your scooter require any repair, take it to a Yamaha dealer, whose skilled technicians have the necessary tools, experience, and know-how to service the scooter properly.

Use only genuine Yamaha replacement parts. Imitation parts may look like Yamaha parts, but they are often inferior, have a shorter service life and can lead to expensive repair bills.

PERIODIC MAINTENANCE AND MINOR REPAIR

EAU42700

Troubleshooting charts Starting problems or poor engine performance

EWA10840



Keep away open flames and do not smoke while checking or working on the fuel system.

1. Fuel

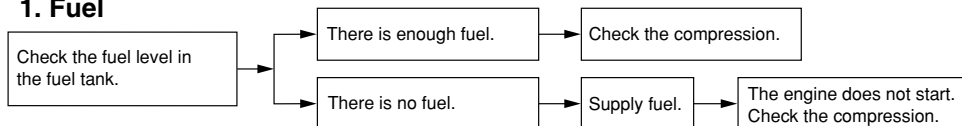

2. Compression

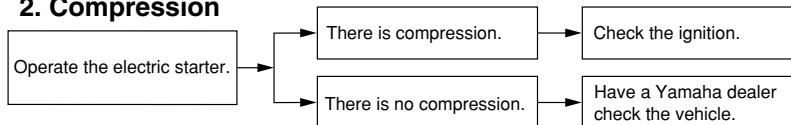

3. Ignition

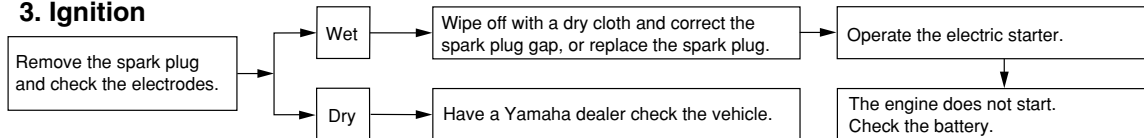

4. Battery

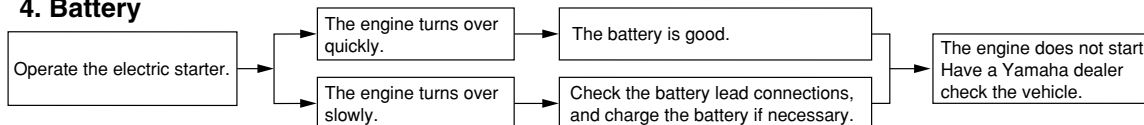

PERIODIC MAINTENANCE AND MINOR REPAIR

Engine overheating

EWAT1040

WARNING

- Do not remove the radiator cap when the engine and radiator are hot. Scalding hot fluid and steam may be blown out under pressure, which could cause serious injury. Be sure to wait until the engine has cooled.
- Place a thick rag, like a towel, over the radiator cap, and then slowly rotate the cap counterclockwise to the detent to allow any residual pressure to escape. When the hissing sound has stopped, press down on the cap while turning it counterclockwise, and then remove the cap.

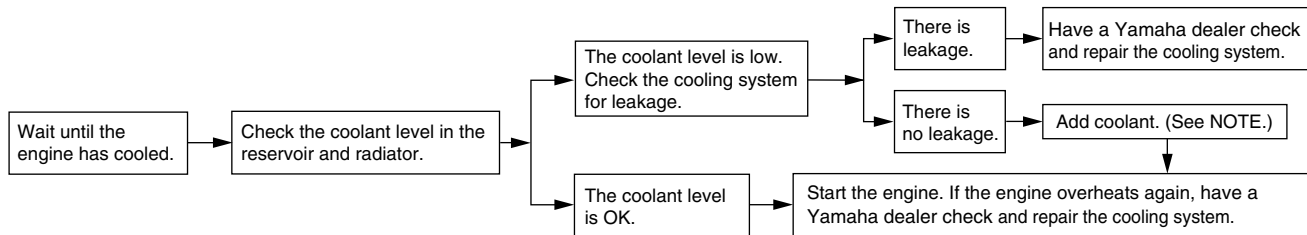

NOTE:

If coolant is not available, tap water can be temporarily used instead, provided that it is changed to the recommended coolant as soon as possible.

SCOOTER CARE AND STORAGE

EAU37833

Matte color caution

ECA15192

CAUTION:

Some models are equipped with matte colored finished parts. Be sure to consult a Yamaha dealer for advice on what products to use before cleaning the vehicle. Using a brush, harsh chemical products or cleaning compounds when cleaning these parts will scratch or damage their surface. Wax also should not be applied to any matte colored finished parts.

EAU26090

Care

While the open design of a scooter reveals the attractiveness of the technology, it also makes it more vulnerable. Rust and corrosion can develop even if high-quality components are used. A rusty exhaust pipe may go unnoticed on a car, however, it detracts from the overall appearance of a scooter. Frequent and proper care does not only comply with the terms of the warranty, but it will also keep your scooter looking good, extend its life and optimize its performance.

Before cleaning

1. Cover the muffler outlet with a plastic bag after the engine has cooled down.
2. Make sure that all caps and covers as well as all electrical couplers and connectors, including the spark plug cap, are tightly installed.
3. Remove extremely stubborn dirt, like oil burnt onto the crankcase, with a degreasing agent and a brush, but never apply such prod-

ucts onto seals, gaskets and wheel axles. Always rinse the dirt and degreaser off with water.

Cleaning

ECA10780

CAUTION:

- **Avoid using strong acidic wheel cleaners, especially on spoked wheels. If such products are used on hard-to-remove dirt, do not leave the cleaner on the affected area any longer than instructed. Also, thoroughly rinse the area off with water, immediately dry it, and then apply a corrosion protection spray.**
- **Improper cleaning can damage windshields, cowlings, panels and other plastic parts. Use only a soft, clean cloth or sponge with mild detergent and water to clean plastic.**
- **Do not use any harsh chemical products on plastic parts. Be sure to avoid using cloths or sponges which have been in contact with strong or abrasive cleaning products, solvent or**

SCOOTER CARE AND STORAGE

thinner, fuel (gasoline), rust removers or inhibitors, brake fluid, antifreeze or electrolyte.

- **Do not use high-pressure washers or steam-jet cleaners since they cause water seepage and deterioration in the following areas: seals (of wheel and swing-arm bearings, fork and brakes), electric components (couplers, connectors, instruments, switches and lights), breather hoses and vents.**
- **For scooters equipped with a windshield: Do not use strong cleaners or hard sponges as they will cause dulling or scratching. Some cleaning compounds for plastic may leave scratches on the windshield. Test the product on a small hidden part of the windshield to make sure that it does not leave any marks. If the windshield is scratched, use a quality plastic polishing compound after washing.**

After normal use

Remove dirt with warm water, a mild detergent, and a soft, clean sponge, and then rinse thoroughly with clean water. Use a toothbrush or bottlebrush for hard-to-reach areas. Stubborn dirt and insects will come off more easily if the area is covered with a wet cloth for a few minutes before cleaning.

After riding in the rain, near the sea or on salt-sprayed roads

Since sea salt or salt sprayed on the roads during winter are extremely corrosive in combination with water, carry out the following steps after each ride in the rain, near the sea or on salt-sprayed roads.

NOTE: _____

Salt sprayed on roads in the winter may remain well into spring.

1. Clean the scooter with cold water and a mild detergent after the engine has cooled down.

ECA10790

CAUTION: _____

Do not use warm water since it increases the corrosive action of the

salt.

2. Apply a corrosion protection spray on all metal, including chrome- and nickel-plated, surfaces to prevent corrosion.

After cleaning

1. Dry the scooter with a chamois or an absorbing cloth.
2. Use a chrome polish to shine chrome, aluminum and stainless-steel parts, including the exhaust system. (Even the thermally induced discoloring of stainless-steel exhaust systems can be removed through polishing.)
3. To prevent corrosion, it is recommended to apply a corrosion protection spray on all metal, including chrome- and nickel-plated, surfaces.
4. Use spray oil as a universal cleaner to remove any remaining dirt.
5. Touch up minor paint damage caused by stones, etc.
6. Wax all painted surfaces.
7. Let the scooter dry completely before storing or covering it.

SCOOTER CARE AND STORAGE

EWA10940

WARNING

- Make sure that there is no oil or wax on the brakes or tires. If necessary, clean the brake discs and brake linings with a regular brake disc cleaner or acetone, and wash the tires with warm water and a mild detergent.
- Before operating the scooter test its braking performance and cornering behavior.

ECA10800

CAUTION:

- Apply spray oil and wax sparingly and make sure to wipe off any excess.
- Never apply oil or wax to any rubber and plastic parts, but treat them with a suitable care product.
- Avoid using abrasive polishing compounds as they will wear away the paint.

NOTE:

Consult a Yamaha dealer for advice on

what products to use.

EAU36560

Storage

Short-term

Always store your scooter in a cool, dry place and, if necessary, protect it against dust with a porous cover.

ECA10820

CAUTION:

- Storing the scooter in a poorly ventilated room or covering it with a tarp, while it is still wet, will allow water and humidity to seep in and cause rust.
- To prevent corrosion, avoid damp cellars, stables (because of the presence of ammonia) and areas where strong chemicals are stored.

Long-term

Before storing your scooter for several months:

1. Follow all the instructions in the “Care” section of this chapter.
2. Fill up the fuel tank and add fuel stabilizer (if available) to prevent the fuel tank from rusting and the

SCOOTER CARE AND STORAGE

- fuel from deteriorating.
3. Perform the following steps to protect the cylinder, piston rings, etc. from corrosion.
 - a. Remove the spark plug cap and spark plug.
 - b. Pour a teaspoonful of engine oil into the spark plug bore.
 - c. Install the spark plug cap onto the spark plug, and then place the spark plug on the cylinder head so that the electrodes are grounded. (This will limit sparking during the next step.)
 - d. Turn the engine over several times with the starter. (This will coat the cylinder wall with oil.)
 - e. Remove the spark plug cap from the spark plug, and then install the spark plug and the spark plug cap.

EWA10950



To prevent damage or injury from sparking, make sure to ground the spark plug electrodes while turning the engine over.

4. Lubricate all control cables and the

pivoting points of all levers and pedals as well as of the sidestand/centerstand.

5. Check and, if necessary, correct the tire air pressure, and then lift the scooter so that both of its wheels are off the ground. Alternatively, turn the wheels a little every month in order to prevent the tires from becoming degraded in one spot.
6. Cover the muffler outlet with a plastic bag to prevent moisture from entering it.
7. Remove the battery and fully charge it. Store it in a cool, dry place and charge it once a month. Do not store the battery in an excessively cold or warm place [less than 0 °C (30 °F) or more than 30 °C (90 °F)]. For more information on storing the battery, see page 6-30.

NOTE: _____
Make any necessary repairs before storing the scooter.

SPECIFICATIONS

EAU2633H

Dimensions:

Overall length:
2230 mm (87.8 in)
Overall width:
780 mm (30.7 in)
Overall height:
1380 mm (54.3 in)
Seat height:
760 mm (29.9 in)
Wheelbase:
1565 mm (61.6 in)
Ground clearance:
120 mm (4.72 in)
Minimum turning radius:
2600 mm (102.4 in)

Weight:

With oil and fuel:
YP400 219.0 kg (483 lb)
YP400A 223.0 kg (492 lb)

Engine:

Engine type:
Liquid cooled 4-stroke, DOHC
Cylinder arrangement:
Forward-inclined single cylinder
Displacement:
395.0 cm³
Bore × stroke:
83.0 × 73.0 mm (3.27 × 2.87 in)
Compression ratio:
10.60 :1

Starting system:
Electric starter
Lubrication system:
Wet sump

Engine oil:

Type:
SAE10W30, SAE10W40, SAE15W40,
SAE20W40 or SAE20W50

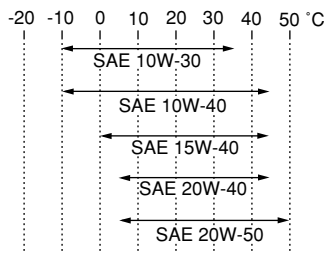

Recommended engine oil grade:
API service SG type or higher, JASO standard MA

Engine oil quantity:

Without oil filter element replacement:
1.50 L (1.59 US qt) (1.32 Imp.qt)
With oil filter element replacement:
1.70 L (1.80 US qt) (1.50 Imp.qt)

Final transmission oil:

Type:
SAE10W30 type SE motor oil
Quantity:
0.25 L (0.26 US qt) (0.22 Imp.qt)

Cooling system:

Coolant reservoir capacity (up to the maximum level mark):
0.32 L (0.34 US qt) (0.28 Imp.qt)
Radiator capacity (including all routes):
1.57 L (1.66 US qt) (1.38 Imp.qt)

Air filter:

Air filter element:
Oil-coated paper element

Fuel:

Recommended fuel:
Regular unleaded gasoline only
Fuel tank capacity:
14.0 L (3.70 US gal) (3.08 Imp.gal)

Fuel injector:

Manufacturer:
AISAN
Model/quantity:
1100-87H90

Spark plug (s):

Manufacturer/model:
NGK/CR7E
Spark plug gap:
0.7–0.8 mm (0.028–0.031 in)

Clutch:

Clutch type:
Dry, centrifugal automatic

Transmission:

Primary reduction system:
Helical gear
Primary reduction ratio:
31/14 (2.214)

Secondary reduction system:

Helical gear

Secondary reduction ratio:

42/16 (2.625)

Transmission type:

V-belt automatic

Operation:

Centrifugal automatic type

Chassis:

Frame type:

Aluminum die-cast and steel tube backbone

Caster angle:

27.00 °

Trail:

100.0 mm (3.94 in)

Front tire:

Type:

Tubeless

Size:

120/80-14M/C 58S

Manufacturer/model:

IRC/MB67

Manufacturer/model:

DUNLOP/D305FL

Rear tire:

Type:

Tubeless

Size:

150/70-13M/C 64S

Manufacturer/model:

IRC/MB67

Manufacturer/model:

DUNLOP/D305L

Loading:

Maximum load:

YP400 189 kg (417 lb)

YP400A 185 kg (408 lb)

* (Total weight of rider, passenger, cargo and accessories)

Tire air pressure (measured on cold tires):

Loading condition:

0–90 kg (0–198 lb)

Front:

200 kPa (29 psi) (2.00 kgf/cm²)

Rear:

250 kPa (36 psi) (2.50 kgf/cm²)

Loading condition:

YP400 90–189 kg (198–417 lb)

YP400A 90–185 kg (198–408 lb)

Front:

200 kPa (29 psi) (2.00 kgf/cm²)

Rear:

250 kPa (36 psi) (2.50 kgf/cm²)

Front wheel:

Wheel type:

Cast wheel

Rim size:

14 x MT3.00

Rear wheel:

Wheel type:

Cast wheel

Rim size:

13 x MT4.00

Front brake:

Type:

Dual disc brake

Operation:

Right hand operation

Recommended fluid:

DOT 4

Rear brake:

Type:

Single disc brake

Operation:

Left hand operation

Recommended fluid:

DOT 4

Front suspension:

Type:

Telescopic fork

Spring/shock absorber type:

Coil spring/oil damper

Wheel travel:

120.0 mm (4.72 in)

Rear suspension:

Type:

Unit swing

Spring/shock absorber type:

Coil spring/oil damper

Wheel travel:

104.0 mm (4.09 in)

Electrical system:

Ignition system:

Transistorized coil ignition (digital)

Charging system:

AC magneto

SPECIFICATIONS

Battery:

Model:

GT9B-4

Voltage, capacity:

12 V, 8.0 Ah

Headlight:

Bulb type:

Halogen bulb

Bulb voltage, wattage × quantity:

Headlight:

12 V, 60 W/55.0 W × 2

Tail/brake light:

LED

Front turn signal light:

12 V, 21.0 W × 2

Rear turn signal light:

12 V, 21.0 W × 2

Auxiliary light:

12 V, 5.0 W × 2

License plate light:

12 V, 5.0 W × 1

Meter lighting:

12 V, 2.0 W × 3

High beam indicator light:

12 V, 1.4 W × 1

Turn signal indicator light:

12 V, 1.4 W × 2

Engine trouble warning light:

12 V, 1.4 W × 1

ABS warning light:

YP400A 12 V, 1.4 W × 1

Immobilizer system indicator light:

LED

Fuses:

Main fuse:

40.0 A

Headlight fuse:

25.0 A

Signaling system fuse:

10.0 A

Ignition fuse:

10.0 A

Radiator fan fuse:

10.0 A

Hazard fuse:

10.0 A

Fuel injection system fuse:

10.0 A

ABS control unit fuse:

YP400A 10.0 A

ABS motor fuse:

YP400A 30.0 A

Backup fuse:

10.0 A

EAU26351

Identification numbers

Record the key identification number, vehicle identification number and model label information in the spaces provided below for assistance when ordering spare parts from a Yamaha dealer or for reference in case the vehicle is stolen.

KEY IDENTIFICATION NUMBER:

VEHICLE IDENTIFICATION NUMBER:

MODEL LABEL INFORMATION:

EAU26381

Key identification number

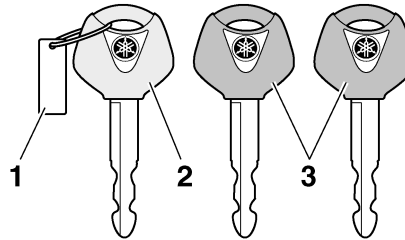

1. Key identification number
2. Code re-registering key (red bow)
3. Standard keys (black bow)

The key identification number is stamped into the key tag. Record this number in the space provided and use it for reference when ordering a new key.

EAU26410

Vehicle identification number

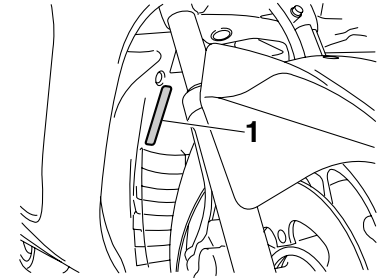

1. Vehicle identification number

The vehicle identification number is stamped into the frame.

NOTE:

The vehicle identification number is used to identify your vehicle and may be used to register it with the licensing authority in your area.

CONSUMER INFORMATION

EAU26500

Model label

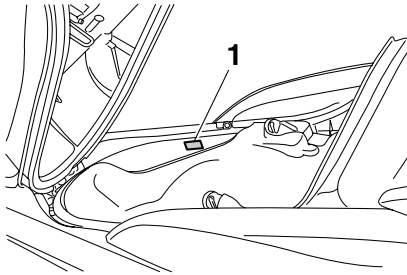

1. Model label

The model label is affixed to the inside of the rear storage compartment. (See page 3-16.) Record the information on this label in the space provided. This information will be needed when ordering spare parts from a Yamaha dealer.

- A**
- ABS (for ABS models)3-12
 - ABS warning light (for ABS models)3-3
 - Acceleration and deceleration5-2
 - Air filter elements and check hoses and V-belt case air filter element6-18
 - Anti-theft alarm (optional)3-9
 - Auxiliary light bulb, replacing6-37
- B**
- Battery6-30
 - Brake fluid, changing6-27
 - Brake fluid level, checking6-26
 - Brake lever, front3-10
 - Brake lever, rear3-11
 - Brake levers, lubricating6-28
 - Braking5-2
- C**
- Cables, checking and lubricating6-27
 - Care7-1
 - Catalytic converter3-14
 - Caution, matte color7-1
 - Centerstand and sidestand, checking and lubricating6-28
 - Coolant6-16
 - Cowlings and panels, removing and installing6-6
- D**
- Dimmer switch3-9
- E**
- Engine break-in5-4
 - Engine oil and oil filter element6-12
 - Engine stop switch3-10
 - Engine trouble warning light3-3
- F**
- Final transmission oil6-15
 - Front and rear brake lever free play6-24
 - Front and rear brake pads, checking6-25
 - Front fork, checking6-29
 - Fuel3-13
 - Fuel consumption, tips for reducing5-3
 - Fuel tank cap3-12
 - Fuses, replacing6-32
- H**
- Handlebar switches3-9
 - Hazard switch3-10
 - Headlight bulb, replacing6-34
 - High beam indicator light3-3
 - Horn switch3-10
- I**
- Identification numbers9-1
 - Ignition circuit cut-off system3-19
 - Immobilizer system3-1
 - Immobilizer system indicator light3-4
 - Indicator and warning lights3-3
- K**
- Key identification number9-1
- L**
- License plate light bulb, replacing6-36
- M**
- Main switch/steering lock3-2
 - Model label9-2
 - Multi-function display3-5
- P**
- Parking5-4
 - Part locations2-1
 - Pass switch3-9
- Periodic maintenance and lubrication chart6-3
- Pre-operation check list4-2
- R**
- Rear brake lock lever3-11
 - Rear brake lock lever cable, adjusting6-24
 - Rider seat, adjusting3-16
- S**
- Safe-riding points1-4
 - Safety information1-1
 - Seats3-14
 - Shock absorber assemblies, adjusting3-18
 - Sidestand3-19
 - Spark plug, checking6-10
 - Specifications8-1
 - Speedometer3-4
 - Starting off5-2
 - Starting the engine5-1
 - Start switch3-10
 - Steering, checking6-29
 - Storage7-3
 - Storage compartments3-16
- T**
- Tachometer3-5
 - Tail/brake light6-34
 - Throttle cable free play, checking6-20
 - Throttle grip and cable, checking and lubricating6-27
 - Tires6-21
 - Tool kit6-1
 - Troubleshooting6-38
 - Troubleshooting charts6-39
 - Turn signal indicator lights3-3
 - Turn signal light bulb (front), replacing6-35

INDEX

Turn signal light bulb (rear), replacing 6-36

Turn signal switch 3-9

V

Valve clearance 6-21

Vehicle identification number 9-1

W

Wheel bearings, checking 6-30

Wheels 6-23



PRINTED ON RECYCLED PAPER

PRINTED IN JAPAN
2006.9-0.2×1 
(E)